



فروشگاه کانون ابزار

تلفن : 021 66 39 39 00

موبایل : 0912 147 3023

www.ali5.ir

Atek ADR 50 Series



HIGH PERFORMANCE "LCD"
DIGITAL READOUTS

INSTRUCTION
MANUAL

Contents

1. ATEK DIGITAL READOUT SYSTEMS	3
1.1. The using advantages of ATEK Sensor' s ADR and Linear Encoder Scales	3
1.2. ATEK Magnetic Linear Scales	3
2. TECHNICAL PARAMETERS	4
3. SYSTEM SETUP	8
3.1. DRO	8
3.1.1. Language	8
3.1.2. Bench.....	9
3.1.3. Brightness.....	9
3.1.4. Ref. Rate.....	9
3.1.5. Sound	9
To enable or disable button beep ON or OFF.	9
3.1.6. Axis Sum	9
3.1.7. Shrink	9
3.2. Axes.....	9
3.2.1. Axis	10
3.2.2. Type.....	10
3.2.3. Resolution	10
3.2.4. Direction.....	10
3.2.5. Index.....	10
3.2.6. Hide	10
3.2.7. Degrees / Minutes / Secons (Dmsec.).....	10
3.3. Reference (Zero Position)	10
3.3.1. Electronic Reference (Zero position of Scale)	11
3.3.2. Mechanical Reference (Mechanical Zeroing Position).....	12
3.4. Compensation (Error Correction)	13
3.4.1. Linear Compensation (Linear Error Correction).....	13
3.4.2. Segmented Compensation (Segmented Error Correction)	14
3.5. Memory.....	16
3.5.1. Parameter	16
3.5.2. Program.....	16
3.5.3. Factory Reset.....	17
3.6. Connection	18
3.7. Test.....	18
3.7.1. Display Test	18
3.7.2. Keypad Test.....	19

3.7.3.	I/O Tests	19
3.8.	Info	19
4.	BASIC FUNCTIONS	20
4.1.	Inc/ Metric Change.....	20
4.2.	Absolute/ Incremental Mode.....	20
4.3.	Axis Reset	20
4.4.	Axes Set	21
4.5.	Setting Half Value of the Display.....	21
4.6.	2D imaging (X-Y Axis)	22
4.7.	Diameter (Lathe)	22
4.8.	Basic calculate on the axis.....	22
4.9.	Recall the datum in memory	23
4.10.	Sleep Mode	23
4.11.	Axis Indicator Hold	24
4.12.	Coordinate Point Memory	26
	Route 1:.....	26
	Route 2:.....	27
5.	ADVANCED FUNCTIONS	28
5.1.	Bolt Hole.....	29
5.2.	Linear Pattern (Hole Grid).....	31
5.3.	Radius.....	33
5.4.	Rectangular Pocket	35
5.5.	Taper Measure	36
5.6.	Angle Measure	38
5.7.	EDM (Erosion Depth Control Function)	39
5.8.	Outputs	41
	Mode 0:.....	42
	Mode 1:.....	43
	Mode 2:.....	43
	Mode 3:.....	43
	Mode 4:.....	44
	Mode 5:.....	44
5.9.	User Program	46

فروشگاه کانون ابزار
 تلفن : 021 66 39 39 00
 موبایل : 0912 147 3023
www.ali5.ir

1. ATEK DIGITAL READOUT SYSTEMS

New ADR50 series color LCD Digital Coordinates Reading Systems are designed to provide maximum efficiency and performance for all metal working machines. ADR50 with 2,3 and 4-axis options has strong memory,1000 program memories and 1,000 tool memories for lathes.Turkish, English, German, Spanish and Portuguese, with five different language in menu,option exists. 6 open collector output capability is available with ADR 50, color LCD screen, and user-defined resolution with the ability to have been designed to meet all your needs.

1.1. The using advantages of ATEK Sensor' s ADR and Linear Encoder Scales

New ADR 50;

- Manufacturing minimizes the time, increases efficiency.
- Manufacturing minimizes the time, increases efficiency.
- Improves the accuracy and sensitivity.
- Improves the quality of the product being handled..
- To move to the next position reduces 80% of the time spent.
- Pays for itself in a short time with the benefits

1.2. ATEK Magnetic Linear Scales

To obtain the highest performance use linear ATEK scales. ATEK MLC series scales to the highest level of precision and reliability. Working with magnetic system that can occur within the environment dust, chips, burrs, factors such as humidity, works seamlessly with cutting fluid. No wear for being contactless, mechanically, there are endless life, maintenance-free.

Suitable for all model bench, for different options and details, please visit www.ateksensor.com

فروشگاه کانون ابزار
تلفن : 021 66 39 39 00
موبایل : 0912 147 3023
www.ali5.ir

2. TECHNICAL PARAMETERS

TEKNİKÖZELLİKLER	
Number of Axes	2, 3, 4
Display	Color LCD
Display accuracy	Users can define their own according to the request
Input signal	Optional Push Pull or TTL A,B,Z (Line Driver A, B, Z, /A, /B, /Z) Incremental Encoder Signals
Weight	2,7 Kg
Power supply	85 – 265 V AC 50/60Hz.
Storage Temperature	- 25 ~ 65 °C
Working Temperature	-10 ~ 45 °C
Relative Humidity	%20 - %85 No Condensation
Protection Class	IP54
Dimension (H x W x T)	202mm x 320mm x 84mm
Housing	Aluminum Injection Housing
Measurement Limits	- 99999,999 mm ~ 99999,999 mm

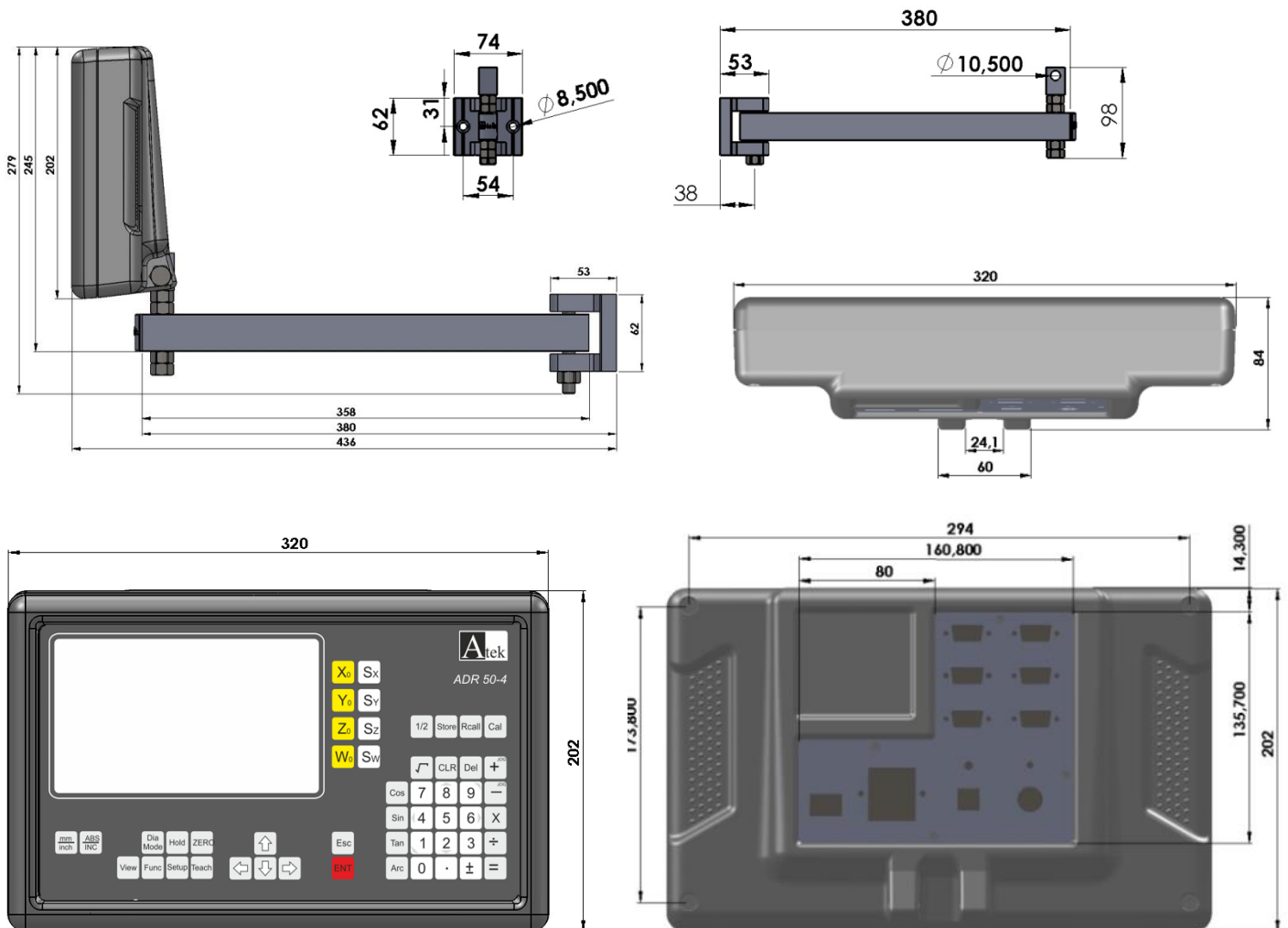



	Metric / Inch measurement selection		Absolute / Incremental Mode selection		Diameter Mode		2D Simulation Mode
	Advanced Function Menu		Sleep Mode		Setup Instalation menu		User Zeros
	Origin "Theach" Button		Recall		Calculator Memory		
	X Axis Selection		Y Ekseni Seçim Butonu		Z Axis Selection		W Axis Selection
	X Axis reset		Y Axis reset		Z Axis reset		W Axis reset
	½ Function		CosineFunction		Sinus Function		Tangent Function
	Calculate		Clear		Single Digit Deletion		Inverse trigonometric functions
	Additional		Substraction		Multipication		Division
	Equal		Square Root		Decimal Point		Sign Change
	Numeric Keys		Arrow Keys				
	Enter		Escape				

فروشگاه کانون ابزار

تلفن : 021 66 39 39 00
 موبایل : 0912 147 3023
 www.ali5.ir

WARNING!

During the installation, please the machine's power off and follow the manual directions.

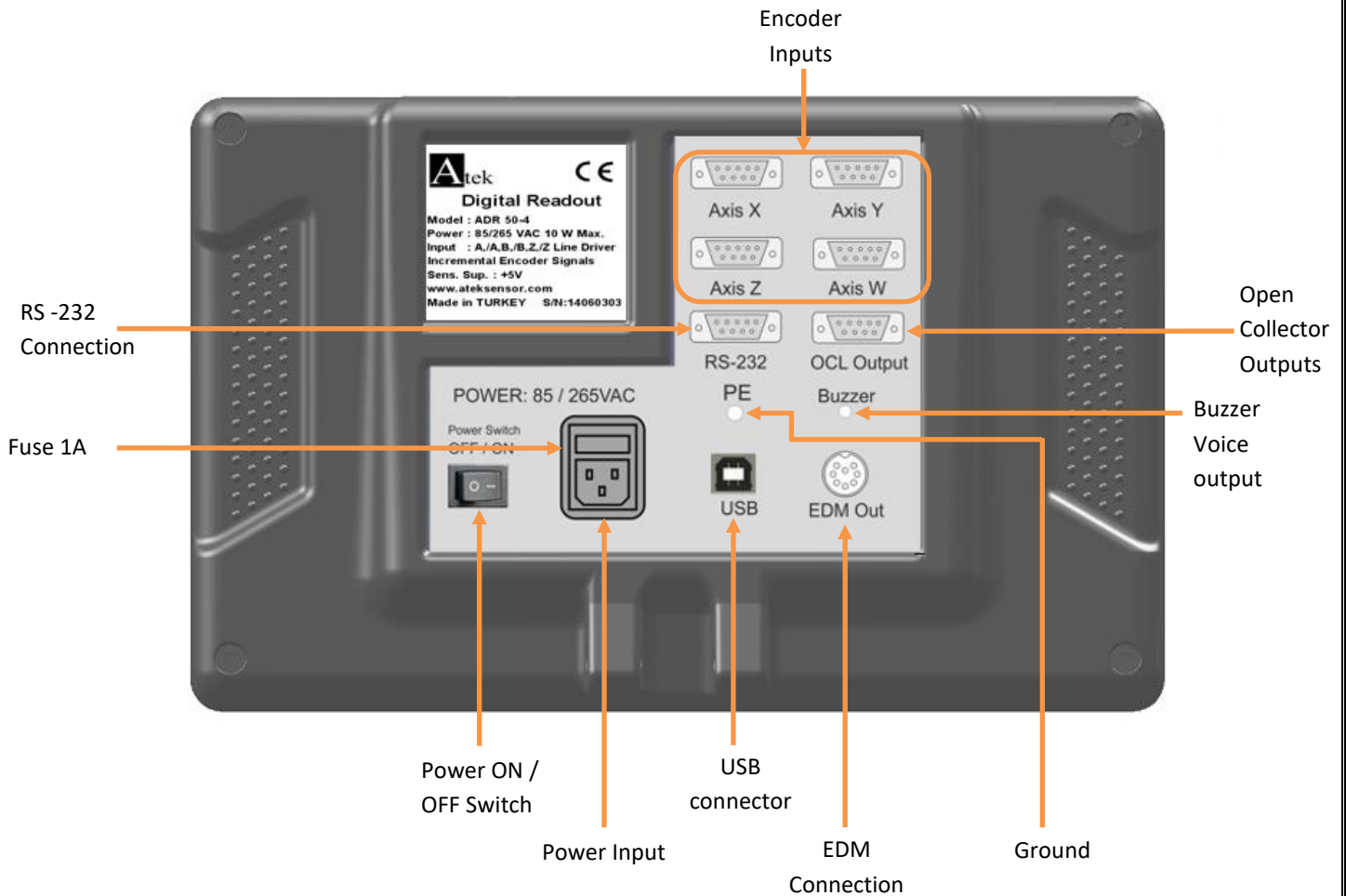

During the connection;

- Definitely do not make connections under the energy.
- Check the On / Off Switch is "Off".
- Check that the voltage supply is suitable for supply voltage limits.
- Use only the power cable that was provided with the product.
- Check the ground connections.
- Do not use a strong magnetic field.
- Do not use in humid environments and at high temperature.
- The unit is always vertical position, the operator can easily use the keyboard and indicators can easily mount to a height of.

Note:4 Axis ADR 10-4 Type DRO Back Panel View.

Encoder Inputs (Differential)

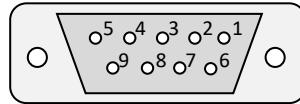

Pin Number	1	2	3	4	5	6	7	8	9
Signal	A	/B	+V	0V	/A	B	/Z	Z	Shield

Encoder Inputs

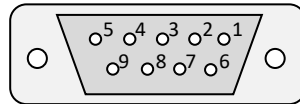

Pin Number	1	2	3	4	5	6	7	8	9
Signal	A	Emty	+V	0V	Emty	B	Emty	Z	Shield

RS – 232Output Port Connection

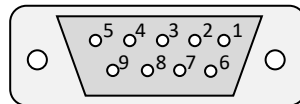

Pin Number	1	2	3	4	5	6	7	8	9
Signal	Boş	Rx	Tx	Boş	0V	Boş	Boş	Boş	Shield

Open Collector Output

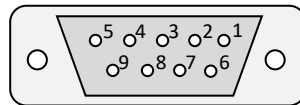

Pin Number	1	2	3	4	5	6	7	8	9
Signal	Out1	Out2	V(+)	GND	Out3	Out4	Out5	Out6	Boş

Note: The power supply must be connected in externally.(5-30 V)

EDM Socket Connection

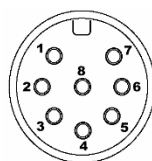

Pin Number	1	2	3	4	5	6	7	8
Signal	NC	COM	NO	Boş	Boş	Boş	Boş	Boş

3. SYSTEM SETUP

After completing all the connections on the back of DRO then on/off switch turned "on" for opening the DRO.

The DRO will display the power UP message momentarily in 3 second as shown below.

Pressing the "Setup" button to toggle the system setup screen.

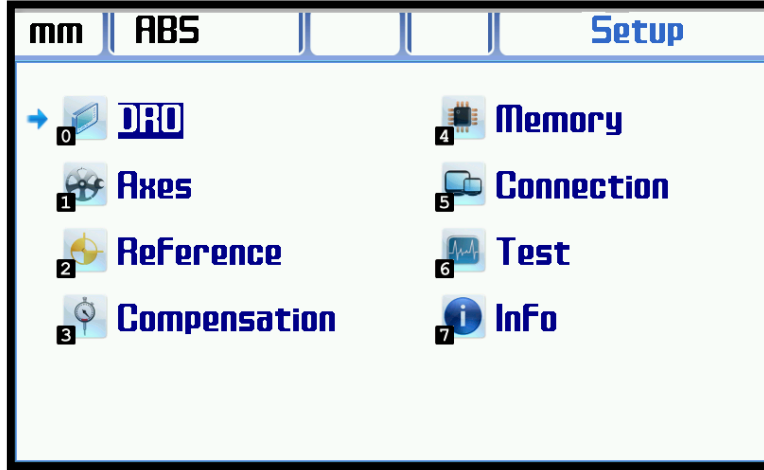

System Setup menu options include directional move with arrow keys when in the desired option, and sub-menu with "ENT" button can be entered. Shortcuts to navigate to the desired option available and it can use the numeric buttons for this operation (to compensation menu it used "3" button).

3.1. DRO

DRO option is used for the mainly features of Digital Readout system. The menu can be navigated with arrow keys up and down and it can be changed with right-left arrow keys. Numerical changes are made with the numerical buttons on the menu. If numeric changes are saved if desired firstly it must be saved with the "ENT" button. After the numeric changes if it use "ESC" button to exit it will not be saved in terms of security.

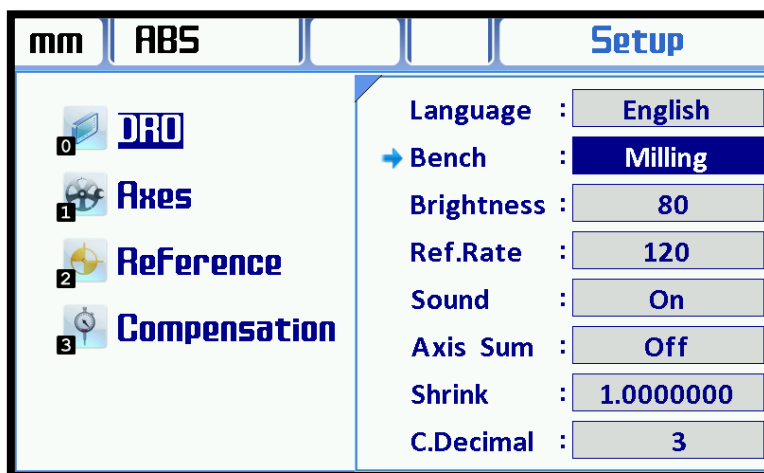

فروشگاه کانون ابزار
تلفن : 021 66 39 39 00
موبایل : 0912 147 3023
www.ali5.ir

3.1.1. Language

Language option, replaces all the language of DRO menu. After option it can be changed with right/left arrow button.

The ADR50 supports 5 language; Turkish, English, German, Spanish and Portuguese. The desired option from the menu, after exit the case of options will be saved.

3.1.2. Bench

DRO uses of the bench will be selected. Selected according to the counter functions varies. There are 6 different option;. Milling, Lathe, Grinding, EDM, Bohrwerk ve general options are available

3.1.3. Brightness

It is the display brightness menu. adjustable from 20 to 100.. Default of display is 80. After entering the desired value and save it with "ENT" buton.If exit with ESC buton it will be not save it.

3.1.4. Ref. Rate

The screen refresh rate. It can be upgraded to prevent flicker of the screen.The value shown is in milliseconds. it can be a value between 1 and 999.After entering the desired value and save it with "ENT" buton.If exit with ESC buton it will be not save it.

3.1.5. Sound

To enable or disable button beep ON or OFF.

3.1.6. Axis Sum

To use Axis collection function is enabled or disabled.To make active the function of additional the value must be "ON"

3.1.7. Shrink

After Plastic items are injected a certain amount of shrinkage and might pull them later. Therefore, before injection the mold size needed to grow at a certain rate. Shrink function with this measure by entering the tolerance are captured.To close the shrinkage the value should remain as a 1,0000000. For example;To adjust shrinkage the 1000 of 5This value must be entered as 1.005

- The value entered > 1: Work piece grows.
- The value entered = 1: Work piece remains the same.
- The value entered < 1: Work piece pulls.

After entering the desired value and save it with "ENT" buton.If exit with ESC buton it will be not save it.

3.2. Axes

Axis of connected to ADR50 will made setting in this menu.the menu can be navigated with arrow keys up and down and it can be changed with right-left arrow keys. Numerical changes are made with the numerical buttons on the menu.If numeric changes are saved if desired firstly it must be saved with the "ENT" button.. After the numeric changes if it use "ESC" button to exit it will not be saved in terms of security.

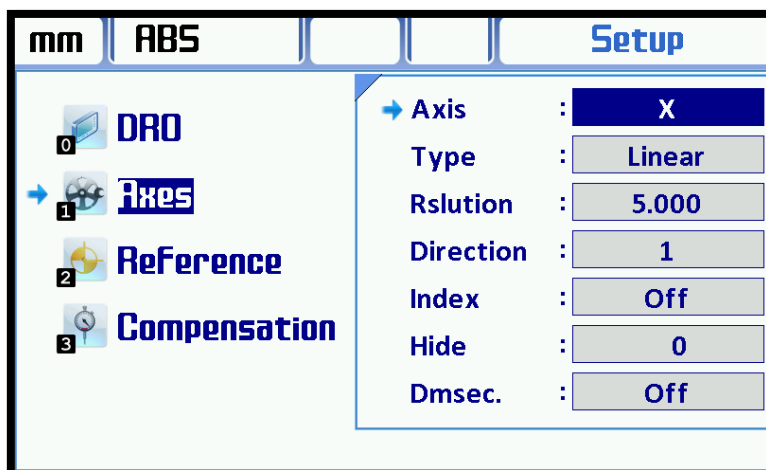

3.2.1. Axis

The axis select to be worked Other settings in below will be applied to the selected axis. The number of these options can vary according to the product used. X, Y, Z and W options in 4-axis ADR50 screen is present.

3.2.2. Type

Measuring type which depending on the axis encoder with must be selected in this menu. There are two option; linear and angular. for Linear position measurement must be selected "Linear", for angular measurement must be selected "Rotary".

3.2.3. Resolution

Encoder resolution of depending on the selected axis is entered in this menu. there is not standard to enter values for resolution. The user can enter selected value. If connected to a five-micron scale the value should be entered five(5.000). Or if angular measurement and connected rotary encoder of axis the resolution of encoder should be entered here. If resolution of rotary encoder is 1024 pulse the value should be entered 1024 (1024.000).

3.2.4. Direction

According to the movement of encoder the direction counting will be determined in this menu. For positive direction counting the value must be entered 1, For negative direction counting the value must be entered -1,

3.2.5. Index

if desired Zeroing Axis with index "Z" signal the value in menu should be made "ON". If the value in this menu is "ON" the Axis will be reset with each incoming index "Z" signal from encoder.

3.2.6. Hide

The digit of desired number on display can be stopped to show with this menu. How many digits to be displayed unwanted entered in this menu. Starting from the smallest digits that number of digits are not displayed.

3.2.7. Degrees / Minutes / Secons (Dmsec.)

If it is to make angular impressions this menu can be used. If the position "ON" the Axis is shown such as degree/ minute/ second. If left position "OFF" the Axis is show only degree. This menu is functionless for Linear measurements..

3.3. Reference (Zero Position)

This menu is used to find zero point of bench. The recommended for sensitive usage; this menu could be used everytime when opening of ADR50.

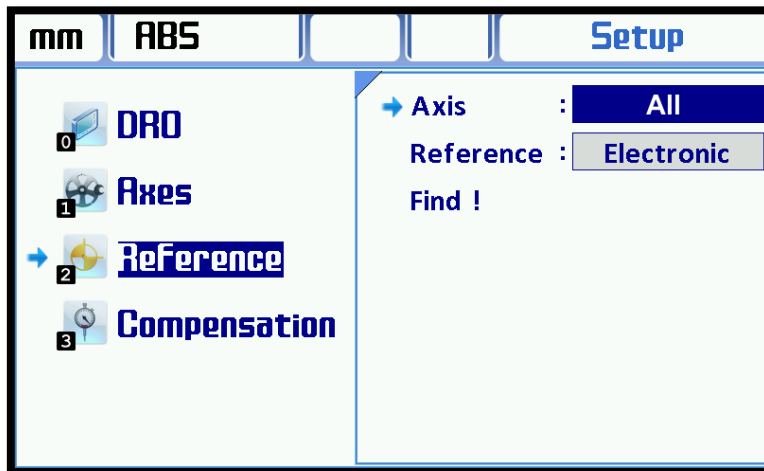

There are two option for usage; Electronic and Mechanical

فروشگاه کانون ابزار
تلفن : 021 66 39 39 00
موبایل : 0912 147 3023
www.ali5.ir

3.3.1. Electronic Reference (Zero position of Scale)

To find out electronic reference the choice of which axis should be selected. If selected "ALL", Reference of all axes can be found out in same time. The reference option is selected as "Electronic", press "ENT" button. When it comes "Bul !" selected, the axes values are displayed as below. When press "ENT" button, the magnifying glass icon will be appeared next to the Axis which is electronic reference to be found.

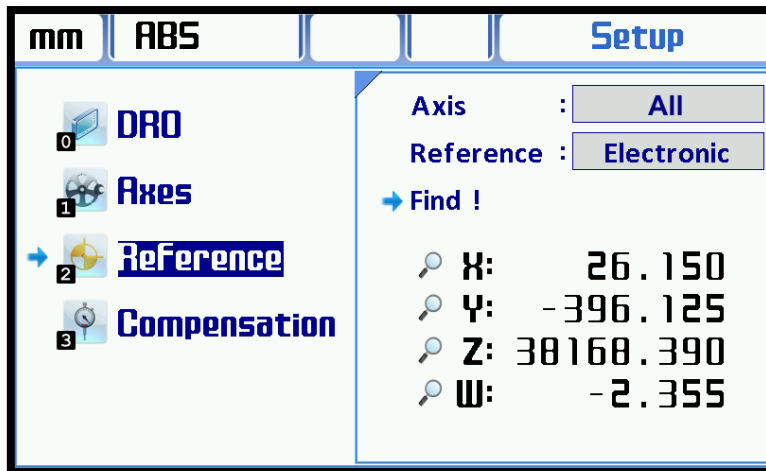

Encoder is moved until to receive the reference signal. The check icon will be appeared next to the Axis which get reference signal and axis will be reset.

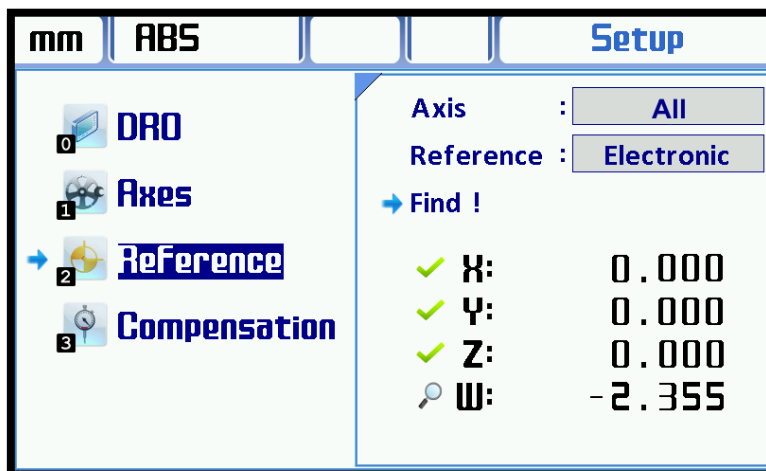

3.3.2. Mechanical Reference (Mechanical Zeroing Position)

To find out electronic reference the choice of which axis should be selected. If selected "ALL", Reference of all axes can be found out in same time. The reference option is selected as "Electronics", press "ENT" button. when it comes "Bul !" selected, the axes values are displayed as a below. When press "ENT" button, the magnifying glass icon will be appeared next to the Axis which is electronic reference to be found.

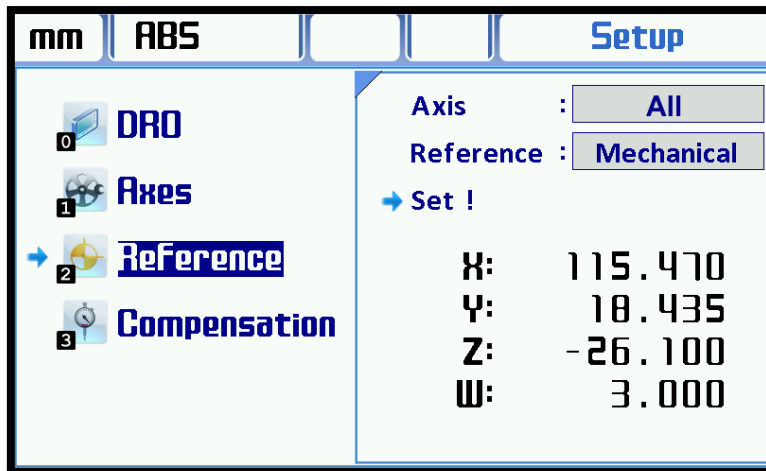

Encoder is moved until to receive the reference signal. The check icon will be appeared next to the Axis which get reference signal and axis will be reset.

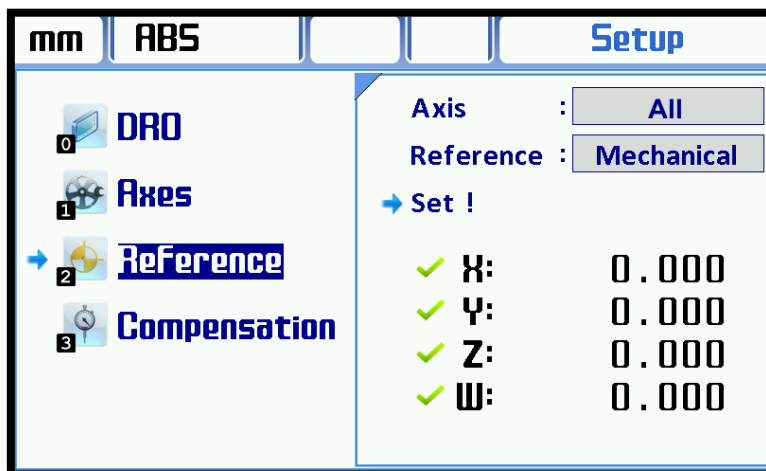

3.4. Compensation (Error Correction)

Compensation, error correction function at benches, are used to compensate mistakes of scales. it can be applied separately for each axis. Linear or sectional can be selected. Sectional compensation can be made up to 100 point. Error correction function can be set only with metric system, works for both measurement system.

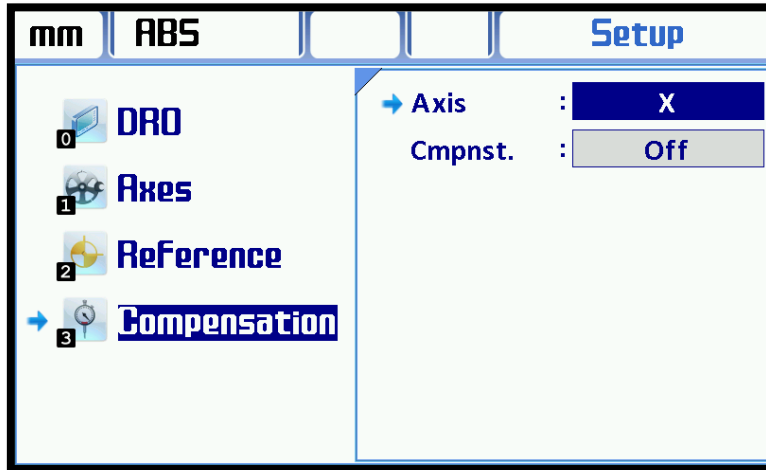

3.4.1. Linear Compensation (Linear Error Correction)

Linear Error Correction, to performed the entering a different error value for each axis. Linear error is proportional increases with distance.

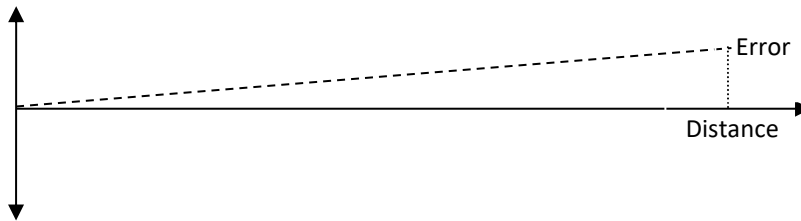

The value as called "Correction Factor" is entered for each axis. Correction Factor can be calculated according to which value is showed how many mm at 1000 mm (1 meter) on the display.

$$\text{Doğrulama Faktörü} = \frac{\bar{L} \times 1000}{L} \quad \begin{array}{l} \bar{L} = \text{Ekranda Gösterilen Değer} \\ L = \text{Gerçekte Ölçülmesi Gereken Değer} \end{array}$$

To active the Linear Compensation; select the required axis to calibrate using X, Y, Z and press "ENT" then the selected "Linear" on the second line and press "ENT" button to save.

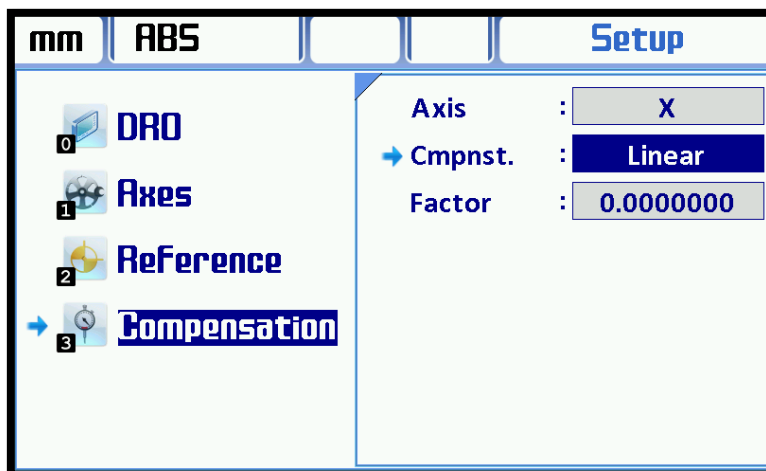

The bottom line will be appeared on the screen. To entered that calculated correction factor on the this line and save with "ENT" button. After the finishing of this function set, log out with "Esc" button

3.4.2. Segmented Compensation (Segmented Error Correction)

If the scale makes errors in different dimensions this function is used for compensation. It can make compensation up to 100 point.

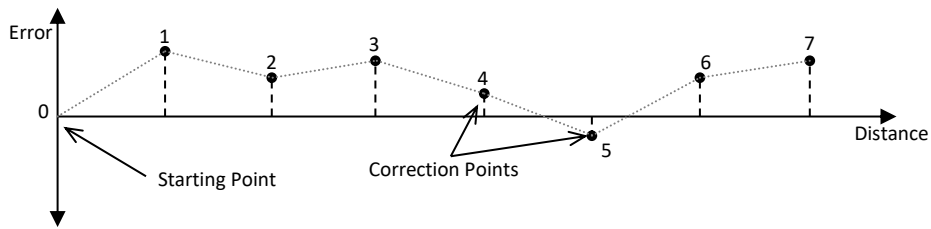

The starting point, zero point or mechanical zero point must have in segmented compensation function. After that determine the correction values with regular intervals.

To active the Segmented Compensation; select the required axis to calibrate using X, Y, Z for segmented compensation with arrow keys then press “ENT” . The selected “Segmented” on the second line and press “ENT” button to save.

There line will be appeared on the screen. the entered the value of distance between points of correction on the length line. The entered the value of how many correction points on the number line. Scroll to “Start” line and press“ENT” button then the sub-window will be opened.

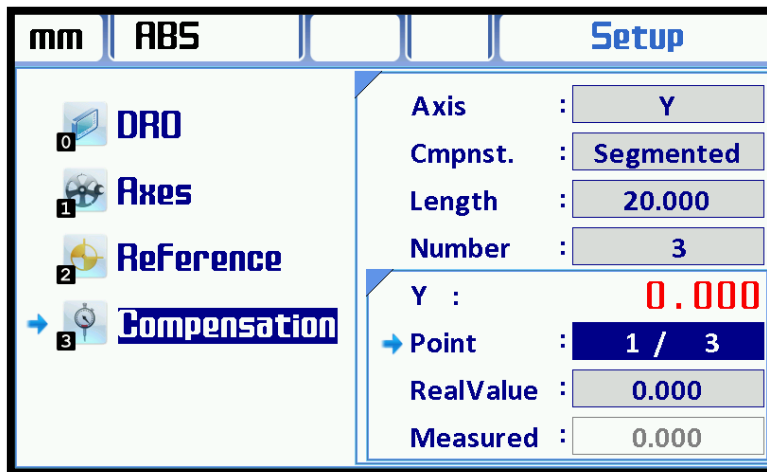

There are four lines in the sub-window. The current value of axis compensation to be applied is displayed on the first line. if this value should be close to the value actually it is displayed in green if it is not close it is displayed in red.If this value is red it is not allow error correction of point for security reasons.

If the entered value of distance between points of correction “20.000” the value is displayed in green between “18.000” to “20.000” and it is allowed to make a compensation.

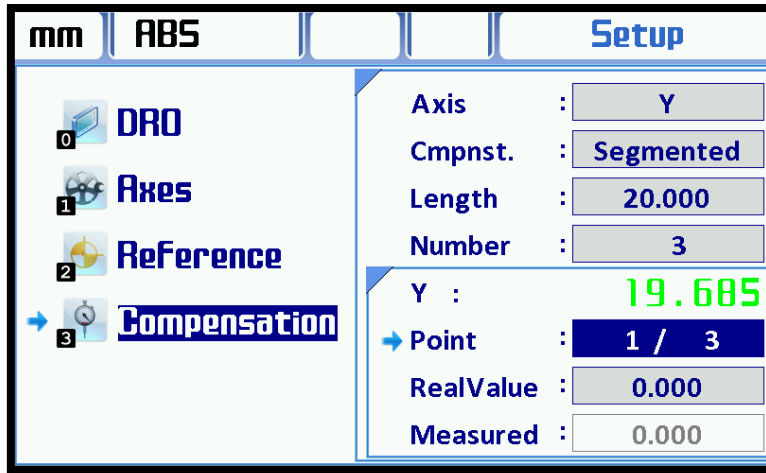

Second line on the "Point" line is displayed count of correction point. Scroll to the required correction point. It is shown as a "A / B", A; count of point and B; total number of correction point. In the above example; it is understood that there are 3 correction point and at the 1. Point.

When the Incorrect Point is reached, The correct value is entered to "RealValue" line on the menu. In the above example; 1. correction point is supposed to show "20.000" but as it shows "19.860". when this point is reached, enter "20" on the "RealValue" line and save with "ENT" button.

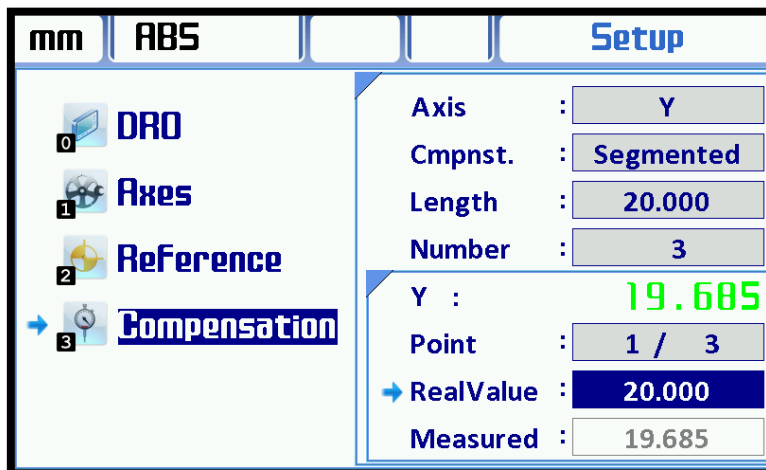

when the correction point is saved, 4. line measured value is displayed. the next point is displayed on the "Point" line and the same process is repeated for this point.

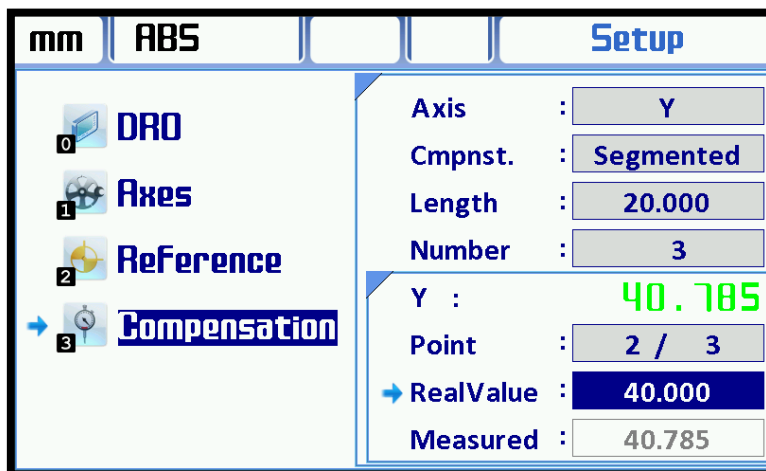

The same process is repeated for all points. After all the correction points are completed, exit from this function with "Esc" button.

3.5. Memory

Memory function is used for; parameters,back up of programs, restore the back up parameters and reset them. Also it can be return the factory defaults in this menu.



3.5.1. Parameter

On the parameter line can be back up all parameters except of parameters of language, bench and motor. In order to back up of the parameter is selected "Backup" with arrow button and press "ENT" button. A query window will open. "Are you sure?" query "Yes" is selected and the "ENT" button to confirm.

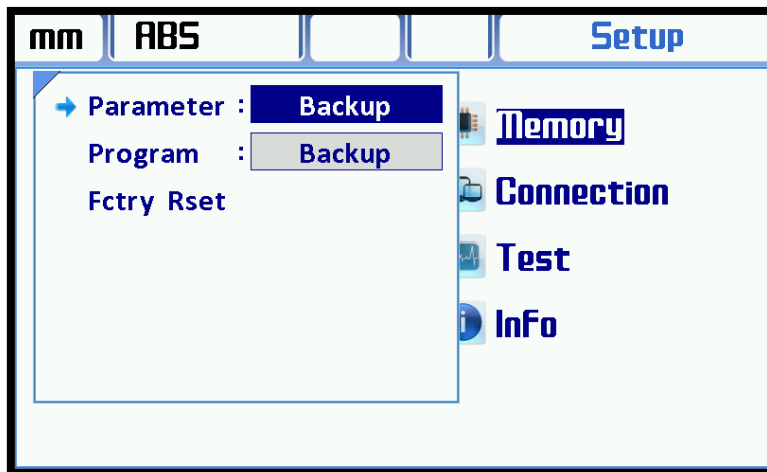

"ENT" button is pressed, first the copy then the verifying will seen on the screen. The backup operation has been completed.

In order to load the previous parameter, the selected "Restore" on the parameter line and press "ENT" button. A query window will open. "Are you sure?" query "Yes" is selected. Parameters will be restored.

In order to reset all parameters according to factory default, the selected "Fctry Rset" on the parameter line and press "ENT" button. A query window will open. "Are you sure?" query "Yes" is selected. The screen that opens "Loading" is displayed. The ADR50 will restart itself. All parameters are returned to factory defaults.

3.5.2. Program

On the "Program" line is provided back up of "User Programs" in function or "Restore". In order to load the previous parameter, the selected "Restore" on the parameter line and press "ENT" button. A query window will open. "Are you sure?" query "Yes" is selected.

"ENT" button is pressed, first the copy then the verifying will seen on the screen. The backup operation has been completed.

In order to backup the program, the selected "Backup" on the program line and press "ENT" button. A query window will open. "Are you sure?" query "Yes" is selected. Parameters will be backed up.

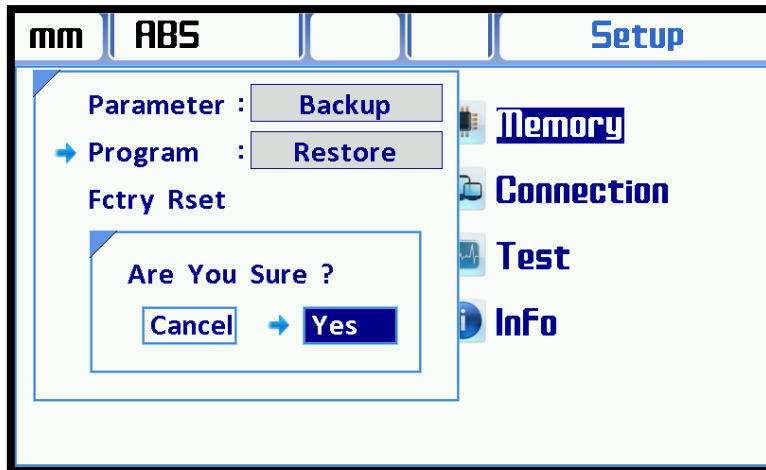

In order to erase all programs, the selected "Erase" on the program line and press "ENT" button. A query window will open. "Are you sure?" query "Yes" is selected. The screen that opens "Erasing" is displayed. All programs have been erased.

3.5.3. Factory Reset

This menu is used to return factory settings of ADR50. Rotating the device to factory settings, only the language, bench type and motor parameters will not change.

In order to return to factory setting, the selected "Fctry Rset" and press "ENT" button. A query window will open. "Are you sure?" query "Yes" is selected and "ENT" button to confirm.

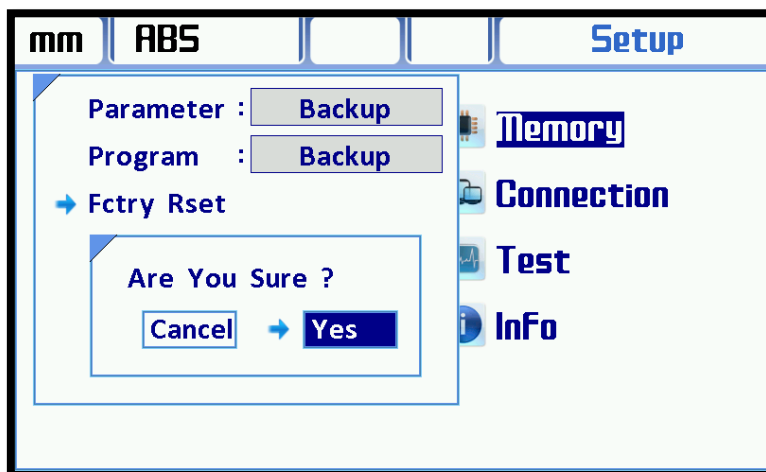

The screen that opens with blue "Loading the factory setting please waiting" is displayed. A short time later the settings of ADR50 is returned the factory settings and will open again.

3.6. Connection

This menu used for connection between computer to ADR50 to change the parameters if required.

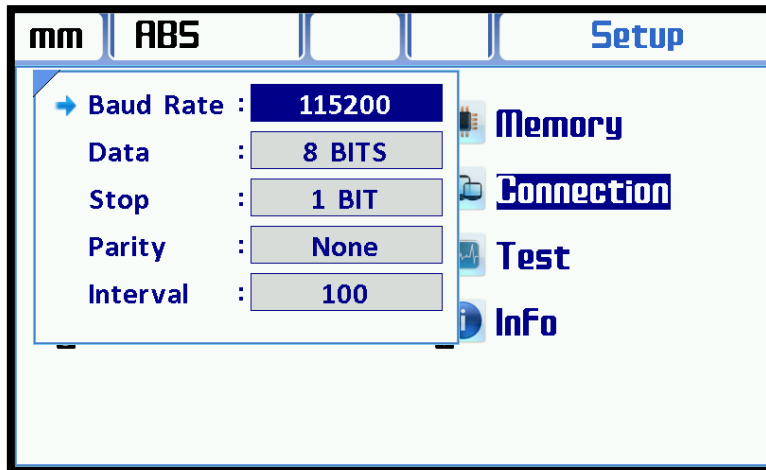

Value of Baud Rate, Parity, stop bits, and periods can be modified in this menu.

3.7. Test

Test menu, ADR50 of display, keyboard, and I/O performed the tests.

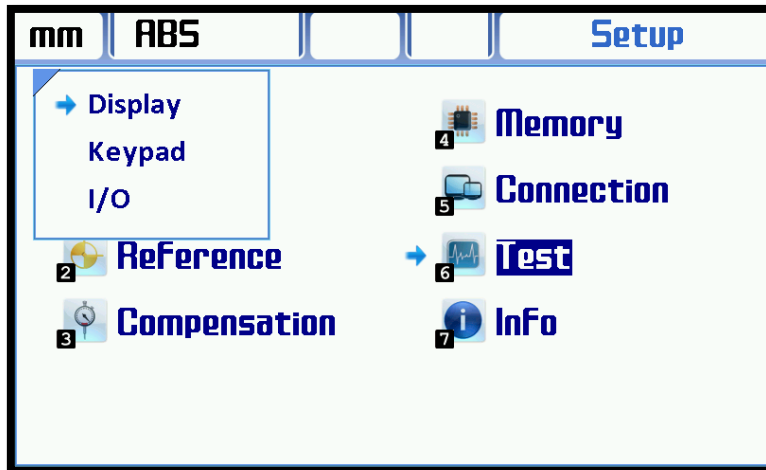

The unit to be tested is selected with arrow button and starts to testing with "ENT".

3.7.1. Display Test

The testing of LCD is performed with display test. the display test is started by pressing "ENT" button on the display line.

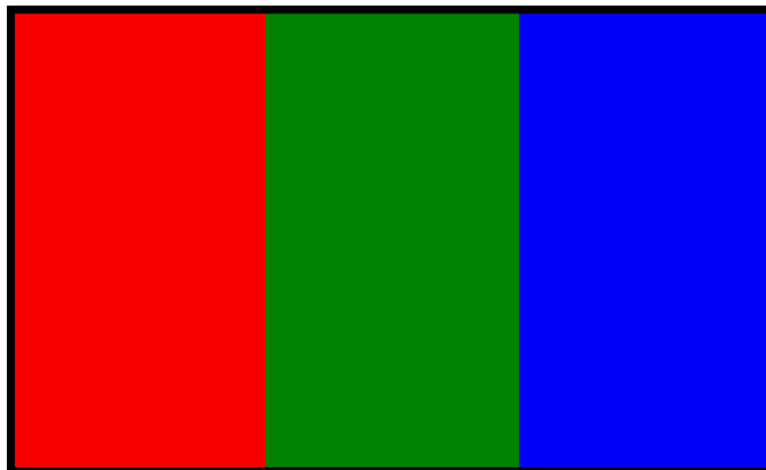

After the Test the LCD screen respectively would be white, red, green, and blue. Thus, in the case of any problems such as dead pixel problem is seen in a clear manner.

3.7.2. Keypad Test

The testing of keypad is performed with keypad on the keypad. The test is started by pressing "ENT" button on the "keypad" line then the keyboard test screen appears.

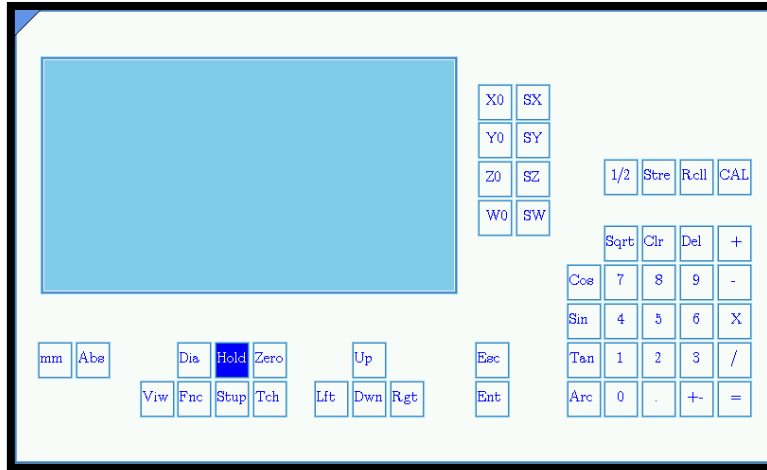

Keyboard test screen when pressing the button, the display changes to blue. All the buttons are pressed and the keyboard test in the same screen, the button that is marked to be seen.

3.7.3. I/O Tests

The testing of output units is performed by I/O test. The testing of output units is started by pressing "ENT" button on the "I/O" line.

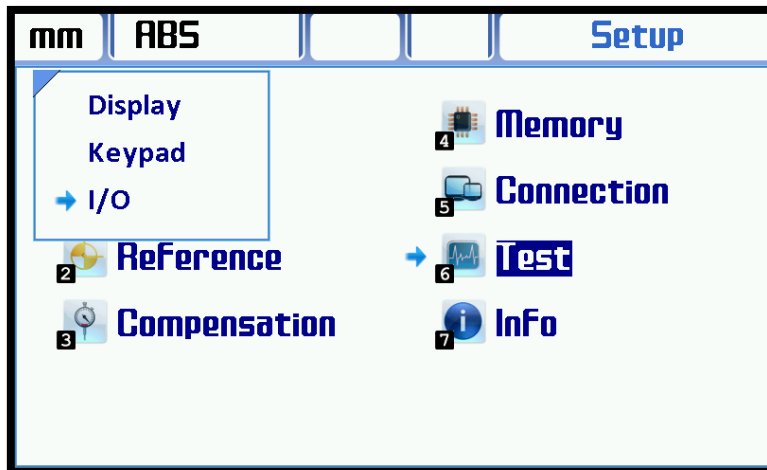

When press "0" EDM relay, press "1" exit-1, press "2" exit-2, press "3" exit-3, press "4" exit-4, press "5" exit-5, press "6" exit-6 will be active. If the same button is pressed again the output will be passive.

3.8. Info

It can be reached the information about ADR50 in this menu.

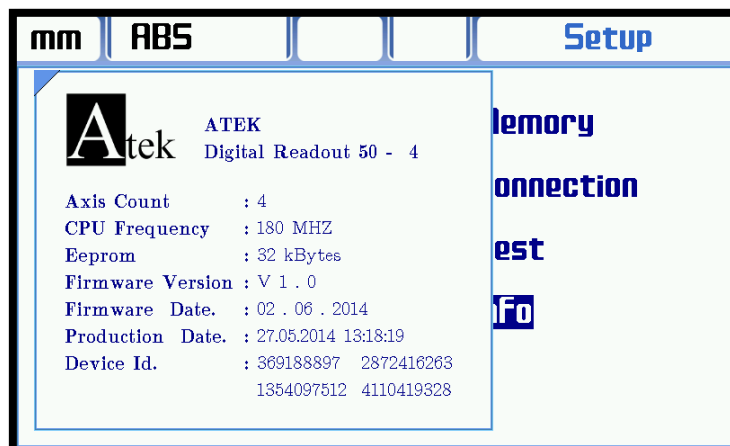

In the window that opens, the number of CPU frequency axis, Eeprom, version, software date, production date and device ID is located.

4. BASIC FUNCTIONS

4.1. Inc/ Metric Change

It can be selected Inc or Metric measurement by  this button. When each press the button the measurement system will be changed.

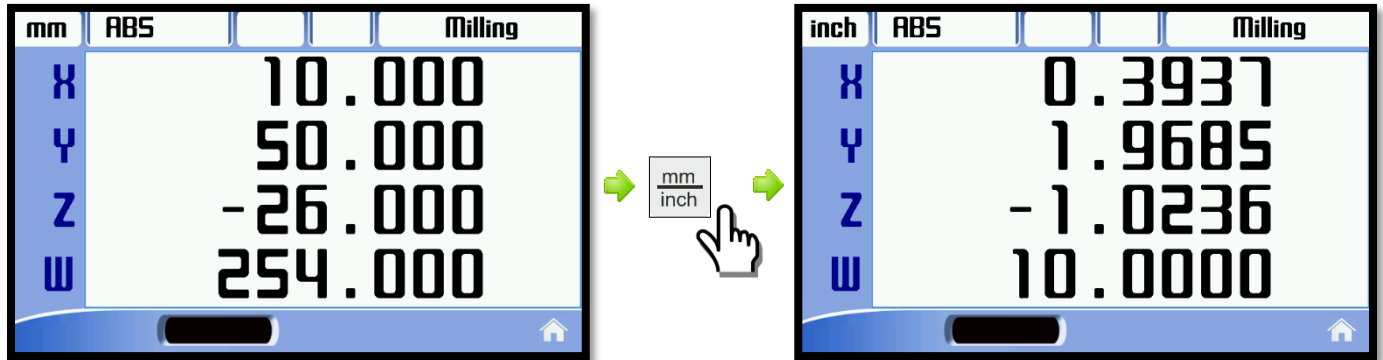

Used measuring system is noted in the upper-left corner of the screen. Measurement system is changed, the values on the screen are converted according to the new system..

4.2. Absolute/ Incremental Mode

The working mode can be selected by ABS/INC button on the keypad. Two different coordinate image system is supported..

- Absolute Mode
- Incremental Mode



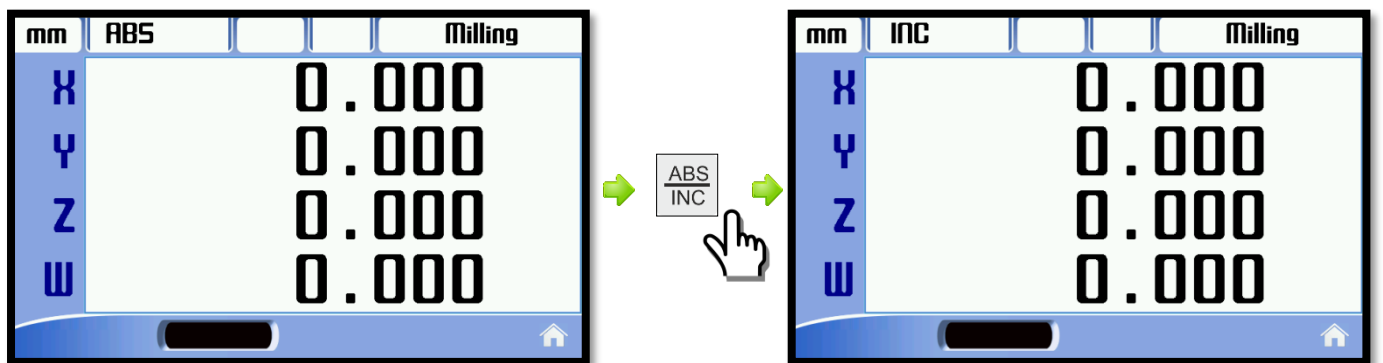

The  button is used for this process. When each pressed the button the working mode will be changed.



The mode of operation used in the upper left corner of the screen next to the measuring system is indicated.

4.3. Axis Reset

The value of axes can be reset with belong to reset button of axes.

 button to zeroing X axis,  button to zeroing Y axis,  button to zeroing Z axis and  button is used to zeroing W axis.

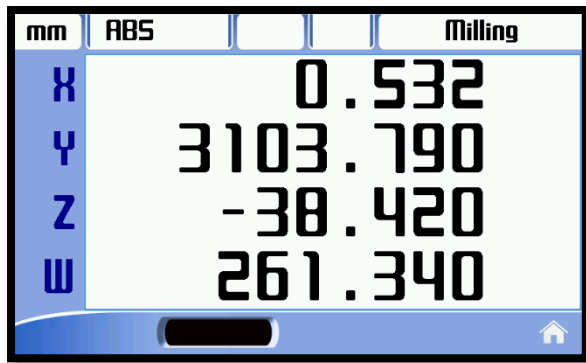

4.4. Axes Set

Axes value is entered manually.

Axis which is to be entered is selected with "axis selector button", entered value and press "ENT".

Sx button to X axis, but **Sy** to Y axis, but **Sz** to Z axis and **Sw** button is used for entering W axis.

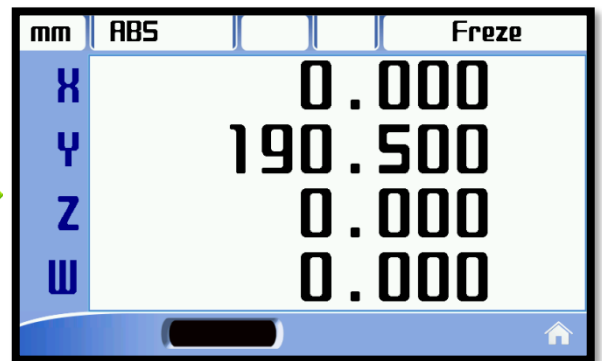
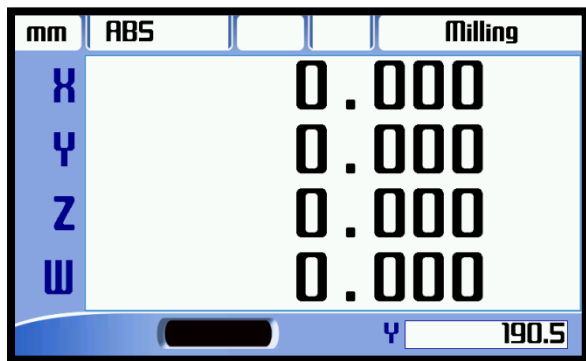
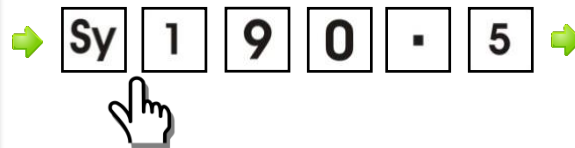
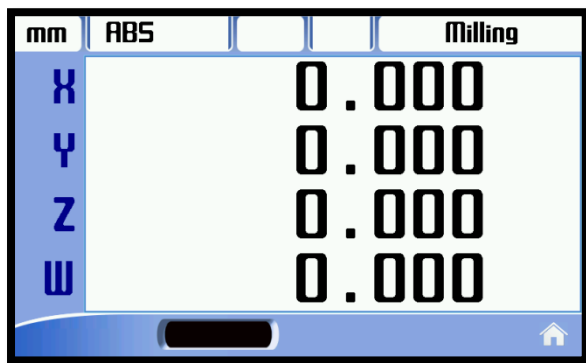

Select the axis to be entered by pressing a small window appears at the bottom right of the screen. Value will appear on the display until press "ENT". "ENT" button is pressed, the value is transferred to the axis.

4.5. Setting Half Value of the Display

The required axis value can be divided in half with the button on the keypad. to perform this operation, selected the desired axis then press "1/2" function button.

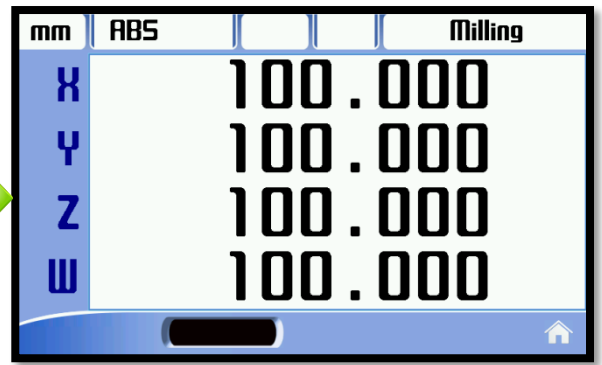
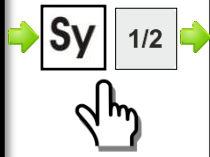
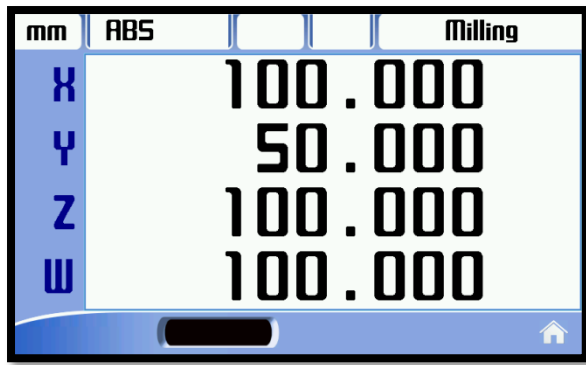

4.6. 2D imaging (X-Y Axis)

The "View" button is used to display in 2D image of X and Y axes.

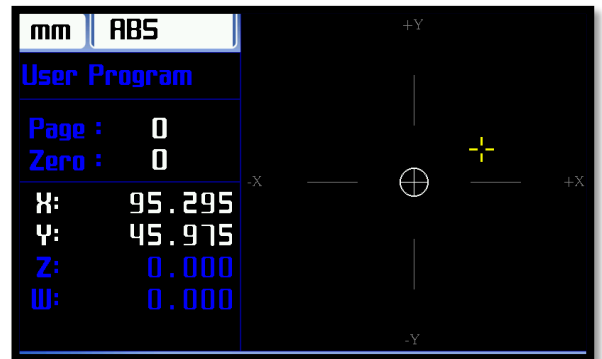
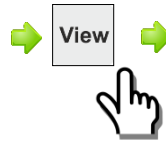

The "View" button is pressed, the screen, the X and Y axes of the coordinate system will be located. The current position is on the left with white text to be specified and will be displayed on the yellow pointer with coordinate system. The display mode again to exit the "View" button or the "Esc" button must be pressed.

4.7. Diameter (Lathe)

This mode is designed for Lathes, the measured value is displayed in doubly, only apply for X axes. This function is standard for lathe mode. "Dia Mode" button is used for turn off the function. The same button is also used for turn on this function.

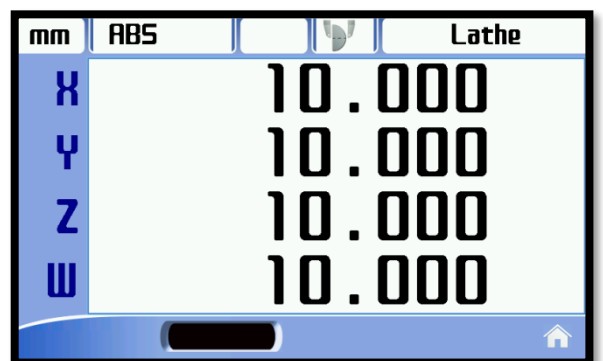
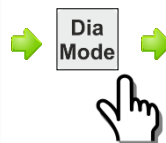
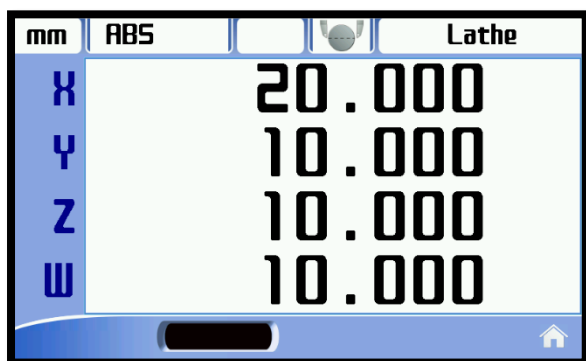

In the example above, the diameter mode which is open was closed. To turn it on again, "Dia Mode" button is used. When diameter mode turn on, the icon of diameter is located next to bench type the upper side on the LCD. When the diameter mode turn off. The icon changes and becomes an icon that measures the radius.

4.8. Basic calculate on the axis

Axis values on a simple addition, subtraction, multiplication and Division operations can be performed. This process is performed without activating the calculator function. First, The axis which is operation must be selected then press choices operation button (+, -, x, /), entered process value then press "ENT" or "(=)" button.

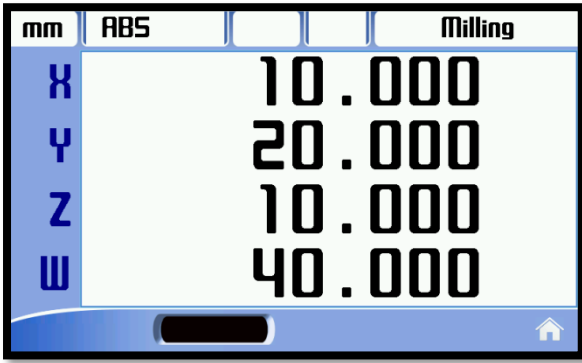
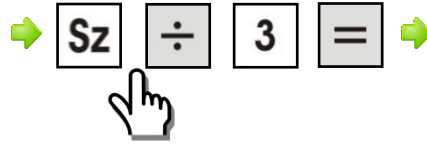
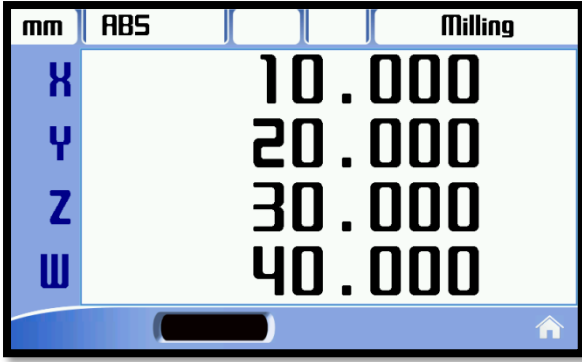

Axis selection button is pressed, it opens a small window at the bottom right, and procedures that can be followed here. The last is equal to (=) or "ENT" button is pressed, the result of the operation that saves the axis.

4.9. Recall the datum in memory

This button, after a while the axis value manually transferring them or simple mathematical operations used to return the old values. Axis value turned into before being changed. Bu işlem için önce bilginin geri çağırılacağı eksene ait seçme butonuna basılır daha sonra "Rcall" butonuna basılır. Son olarak "ENT" butonuna basıldığında değer çağırılmış olacaktır.

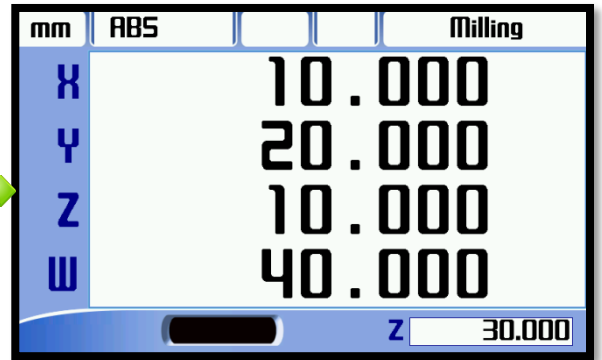

When press the axis selection button, the small window at bottom right opens. "Rcall" button pressure the previous value appears in this window. "ENT" button is pressed, this value is transferred to the axis. In case of cancellation of transfer value press "Esc" button instead of "ENT".

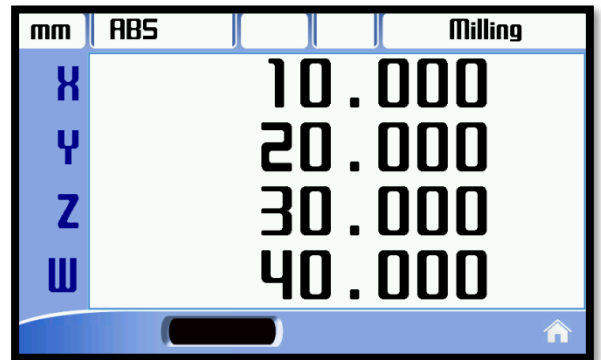

4.10. Sleep Mode

In sleep mode the screen indicators and buttons (except Hold) becomes disabled. When the screen is not used, it would be blocked to intervene by 3. Persons. when Indicators and buttons are disabled, the process which incoming signals from scales is continued. So if the system in sleep mode, changing the location of the bench table detects this position of it transfers to new user.

During the breaks and at the end of overtime, the screen can be left in sleep mode until working again. thus, to intervene in the system is blocked such as, When on the job the user can continue from where it left off.

The system is taken with the "Hold" button to enter sleep mode and the same button is removed.

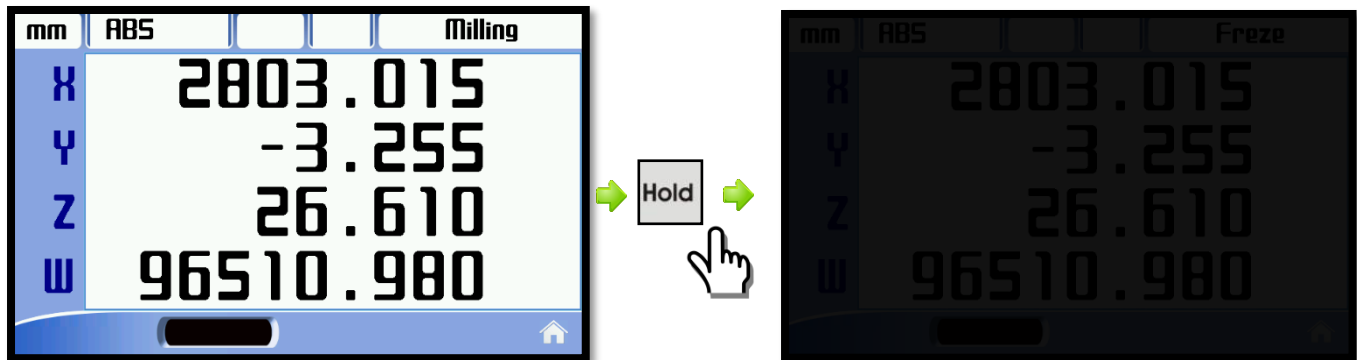

4.11. Axis Indicator Hold

The value of desired axis can be frozen with Axis freeze function indicator. After frozen-axis value if the machine was moving, the tray table axis values can continue from the new position, or you can continue the from frozen values.

To activate the function of Axis freeze function indicator, press button of desired axis then the "Hold" button is pressed. A lock icon appears next to the frozen axes. Press again "HOLD" button and you can move the table. The axis will be continued with the last position value. If you exit by "ESC" button if the table position is changed the axis value continues with the new value.

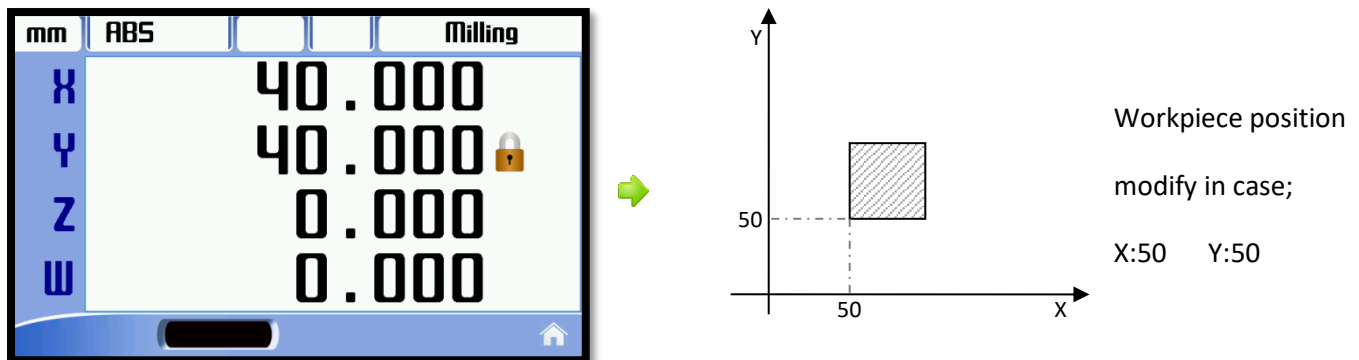
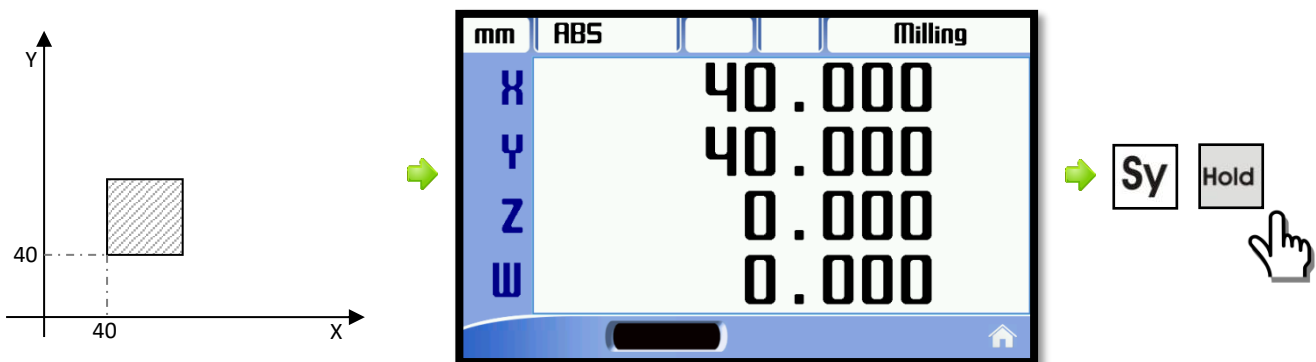

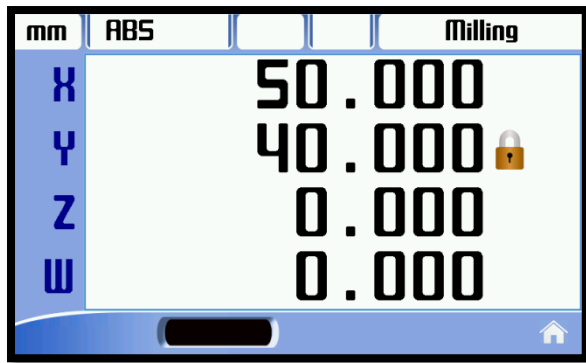

There are two different ways to exit the function.

Route 1:

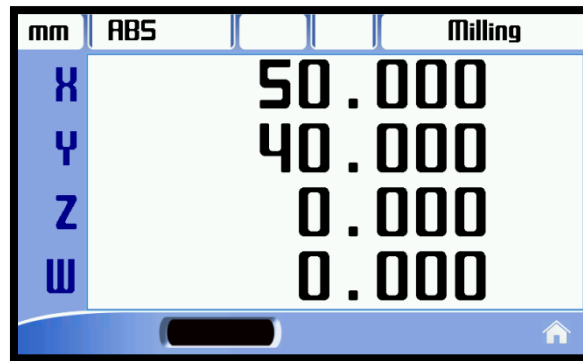
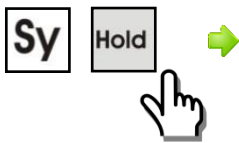

Even though Y Axis the position is changed, continue from the hold value.

Route 2:

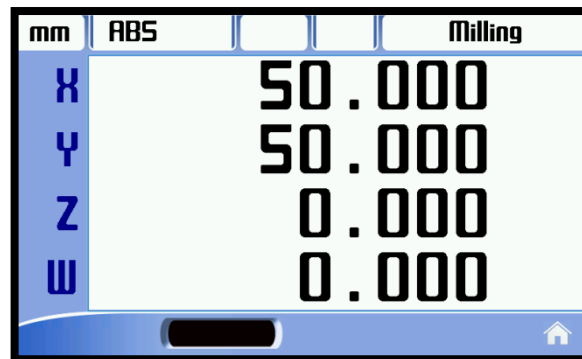
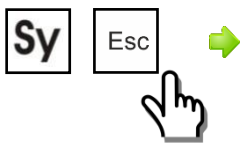

The new location is shown for changed of Y axis position.

4.12. Coordinate Point Memory

1,000 pieces different coordinate point can be recorded in ADR50. Thus workpieces in series does not need to be repeated to enter the coordinates again. This function also can be used for lathe as a the memory of the team.

This function can be used in 2 different ways.

Route 1:

فروشگاه کانون ابزار

تلفن : 021 66 39 39 00

موبایل : 0912 147 3023

www.ali5.ir



Tables will be brought to the location stored.

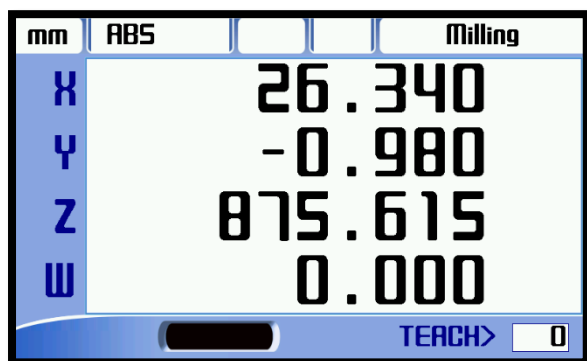

"Teach" button is pressed, the right hand side of the screen under appears "Teach" sign and beside a white box.



Write memory number and press "ENT" to save.

Route 2:



Tables will be brought to the location stored.



The "Zero" button is pressed and the desired memory record number is entered. To go to this memory number the press "ENT" button.

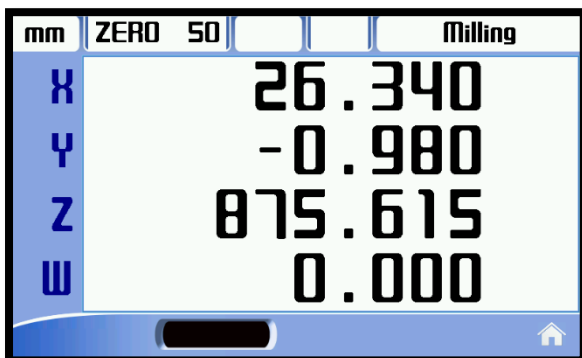

The memory number shows in the previous screen, a "ABS" shown in the window.

One by one axis reset button (X0, Y0, Z0, W0) is pressed.

The coordinates are saved to memory.

- The memory of point coordinates can be entered in manual one by one at the same time. In order to get points of coordinate in memory, press "ZERO" button and enter the desired memory number then press "ENT" button. to enter X coordinate "Sx", to enter Y coordinate "Sy", to enter Z coordinate "Sz", to enter W coordinate press "Sw" button and coordinate values are entered with the numeric buttons.

Points of coordinate in memory is referenced by the "Absolute" operation mode.

It can be reached to points of coordinate by using   buttons.

5. ADVANCED FUNCTIONS

"Func" button is used to enter advanced functions menu. When "Func" button is pressed, a screen opens listing of functions, as a following.

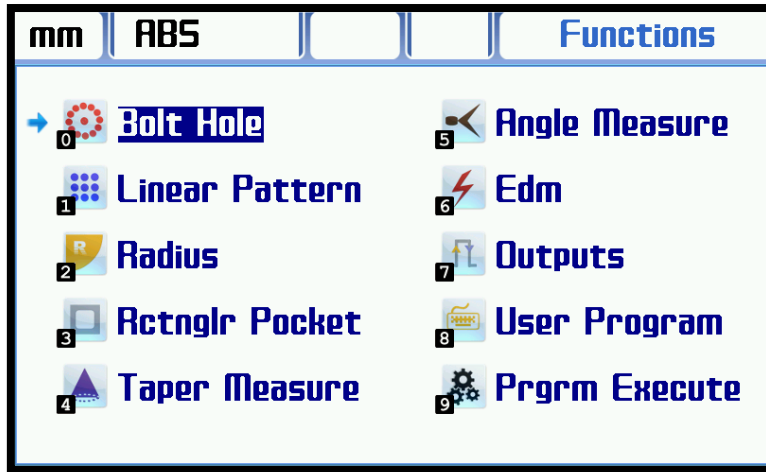

Among the options at the functions of menu can be moving with the arrow keys and when the desired options, it can be entered in submenu with "ENT" button. Shortcuts are available to move the desired option with numeric buttons. ("2" button is used to "Radius" menu).

5.1. Bolt Hole

Circular hole drilling (divisor) function is used to drill holes equally spaced on the circle.

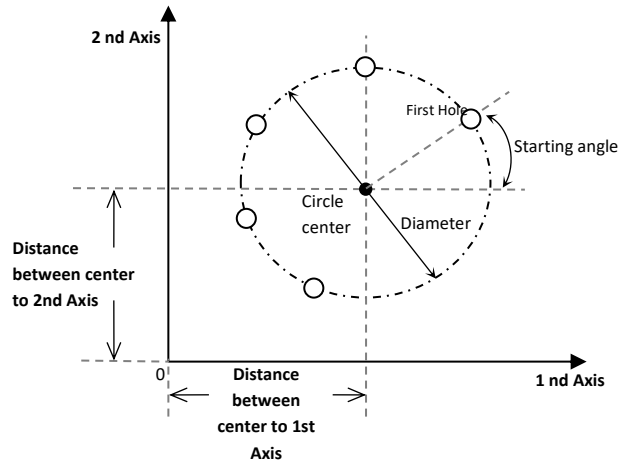

To enter the divisor menu, press "0" button while on the function screen or to reach the divisor with arrow keys. then press "ENT" button.

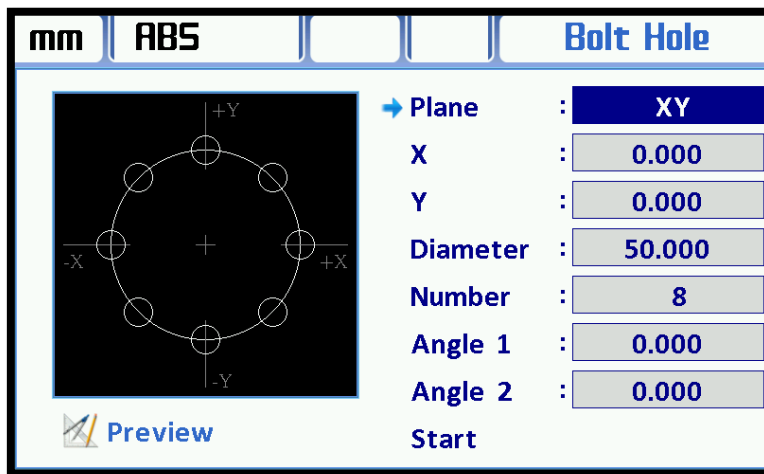

8-line display comes on the screen. The plane which the process to apply is determined with direction arrows on the "Plane" line and selected with "ENT" button.

2 line belonging to selected plane is located in just below. the entered a distance value which is processed axis to "0" point.

The radius of the circle is entered on the "Diameter" line.

The number of holes is entered on line.

Angle of first hole on "Angle 1" line, angle of last hole on "Angle 2" line are entered and saved with "ENT" button.

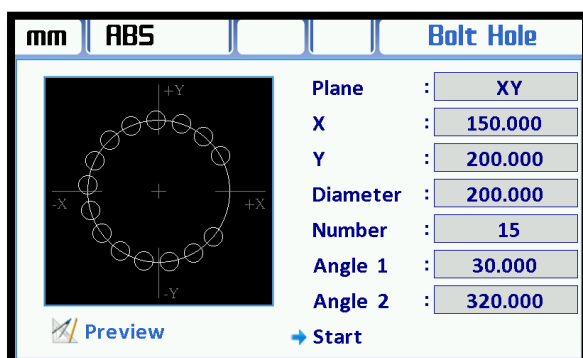

When all data are entered, the preview image on the left side will be updated according to this data.

Click "Start" icon then press "ENT" button and the function will be started.

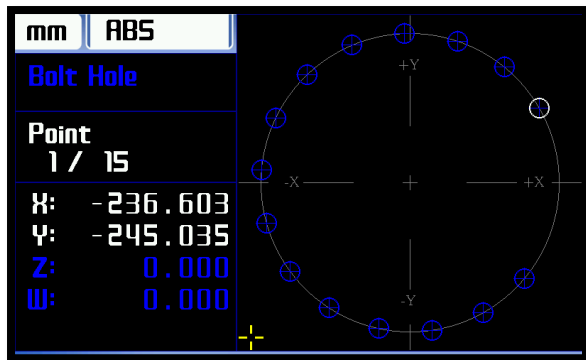

When function starts up the simulation screen will open as the side. The current position is shown with a yellow marker.

The first point to be processed are indicated with white. In the process axes are displayed the value on the left window. This value of 0 means that it has reached the first point.

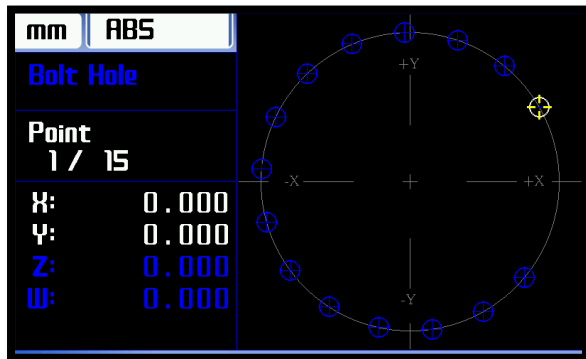

When the first point is reached, the axis values are displayed as 0 and it is reached first point of the simulation screen.

first point drilling operation is applied. In order to move to next point the up and down keys or "ENT" button are used.

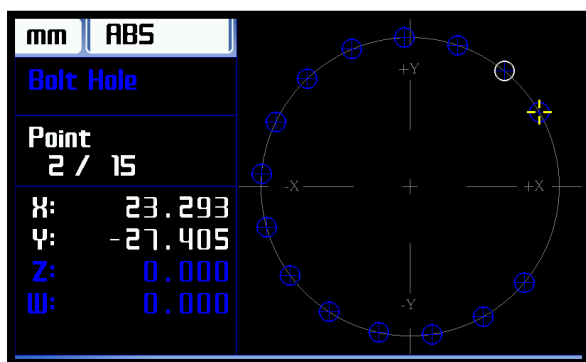

The first point can be processed, "ENT" or the down arrow button is pressed, the 2nd point in the simulation screen is displayed as white.

The new values is installed to Axes. These axes are moved again until when the values reach to zero. When it is zero, reached the 2nd. Point. This point is processed too and to pass the 3rd point, press "ENT" or the down arrow button. All the points are processed in the same way and the function is exited with "Esc"

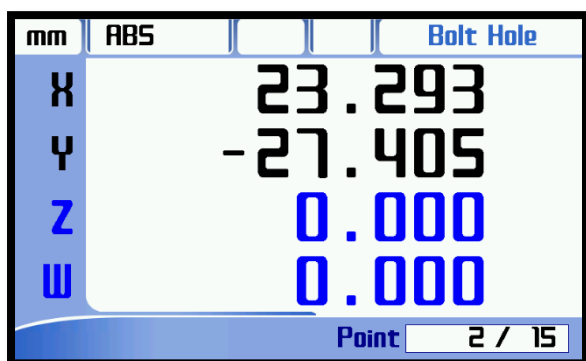

The "View" button can be used to pass the without simulation image. The operated axis values indicated with black, the none operated axis values indicated with blue on the screen.

How many point and at the right bottom and the match point when courting are displayed at right bottom. These axes are moved again when the values reach to zero. And When it is zero the operation is done. to pass the next point, press "ENT" or the down arrow button. the function is exited with "Esc" button.

5.2. Linear Pattern (Hole Grid)

The linear pattern function, the hole grid is created by user-specified number of line and columns contains the on the workpiece.

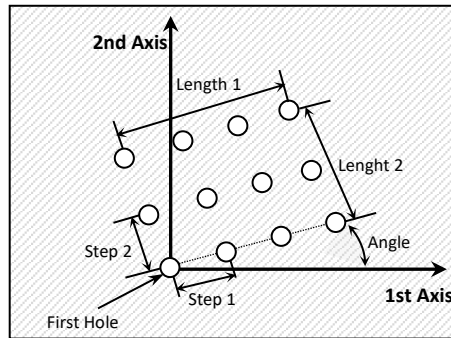

To enter the the Linear Pattern Function, press "1" button while on the function screen or to reach the Linear Pattern with arrow keys then press "ENT" button.

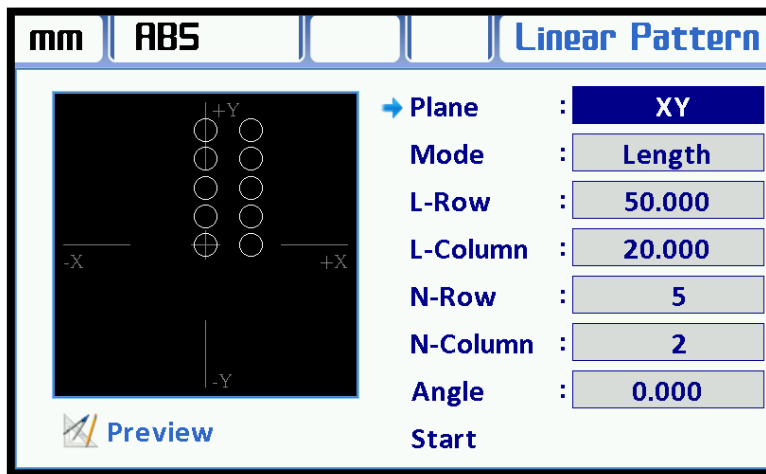

An screen is displayed 8 lines. The Processed plane is determined with arrow keys "Plate" line on the top and selected with "ENT" button.

There are two option on the "Mode" line, "Step" and "Lenght", under the "Plane" line. If selected "Step" the distance between holes in line and columns are indicated for processing. If selected "Lenght" the distance between the first hole and the last hole of line and columns is indicated. The suitable option selected here for processing.

If "Mode" option is selected as the length, the distance between first hole to last hole on the "L-Row", the distance between first column to last column on the "L-Column" is entered. If "Mode" option is selected as "Step", The distance between hole of rows on the "L-Row" line, the distance between hole of columns on the "L-Column" line.

How many hole row to be created is entered on the "N-Row" line. How many column row to be created is entered on the "N-Column" line.

If it does process with angle, this value of angle is entered the "Angle" line.

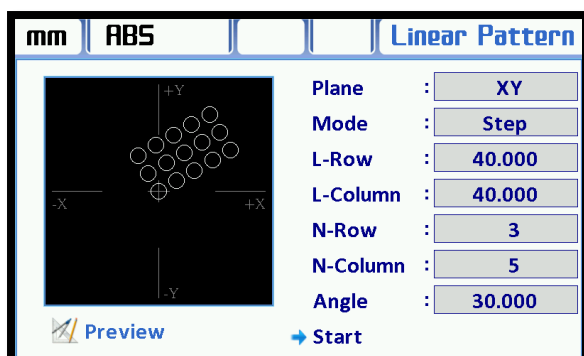

When all datum are enter, the preview image on the life side will be update according to this data.

To start up the function; "Start" then press "ENT" button.

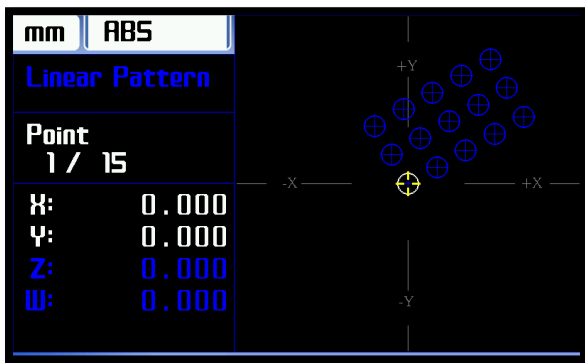

When function is started the simulation screen will open as on the side. The current position is shown with a yellow marker.

The first point to be processed are indicated with white. The axis which will be operation values are displayed in window on the left. If these values are zero its mean is reached the first point. The first point is applied a process. The down arrow or "ENT" button is used to pass to the next point Count of point and the total number of points can be displayed on the left screen.

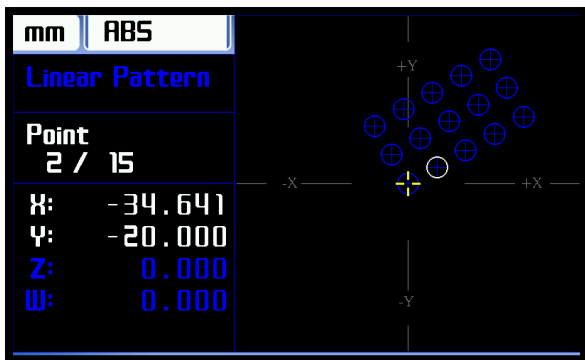

The first point can be processed and when press "ENT" or down arrow button the second point is displayed on the simulation screen as a white.

the new values are loaded to the axis. These axes are moved again until when the values reach to zero. When it is zero, reached the 2nd. Point. This point is processed too and to pass the 3rd point, press "ENT" or the down arrow button. All the points are processed in the same way and the function is exited with "Esc"

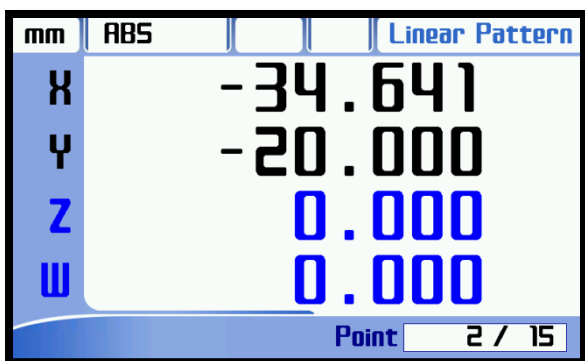

The "View" button can be used to pass the without simulation image. The operated axis values indicated with black, the none operated axis values indicated with blue on the screen.

How many point and at the right bottom and the match point when courting are displayed at right bottom. These axes are moved again when the values reach to zero. And When it is zero the operation is done. to pass the next point, press "ENT" or the down arrow button. the function is exited with "Esc" button.

5.3. Radius

It is used for sensitive circular cutting on workpiece. In this process, the user determines which angle to end or starting of cutting process. This function is not given only the opportunity for sensitive working on the other hands saves time and minimizes the amount of scrap.

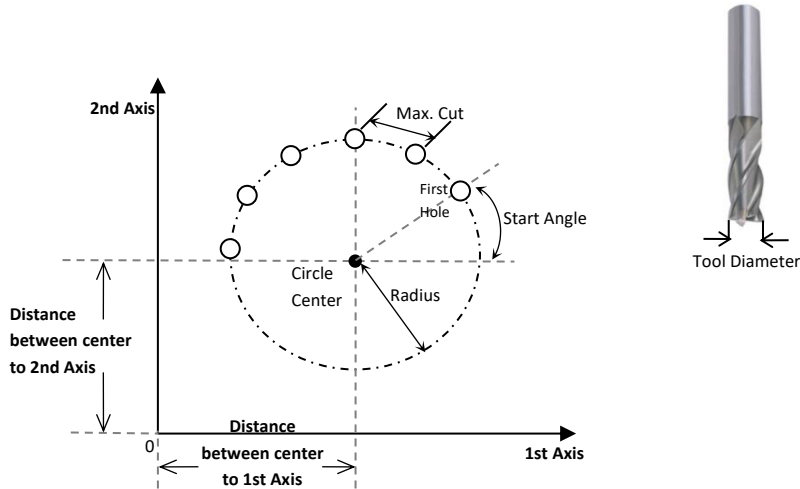

To enter the the Radius mode, press "2" button while on the function screen or to reach the "Radius" with arrow keys then press "ENT" button.

An screen is displayed 8 lines. The Processed plane is determined with arrow keys "Plane" line on the top and selected with "ENT" button.

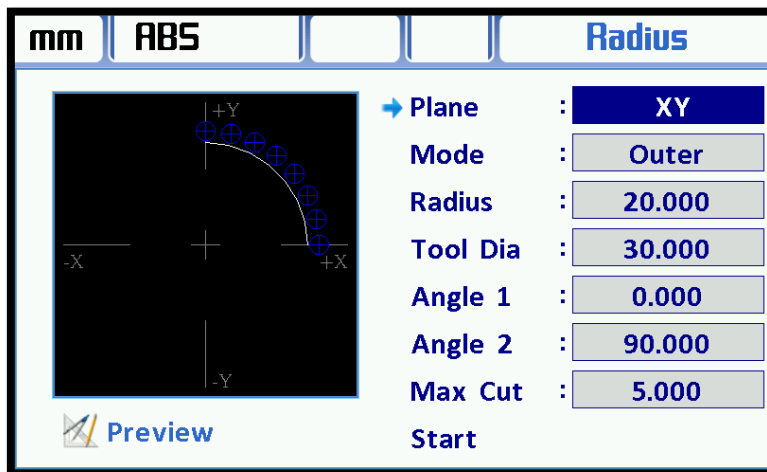

There is "Mode" line just below the "Plane" line. Tabs that you connect to the workpiece; If it is request to give outer edges ovality the selected "Outer" on the "Mode" line. If it is request to give inner edges ovality the selected "Inner" on the "Mode" line.

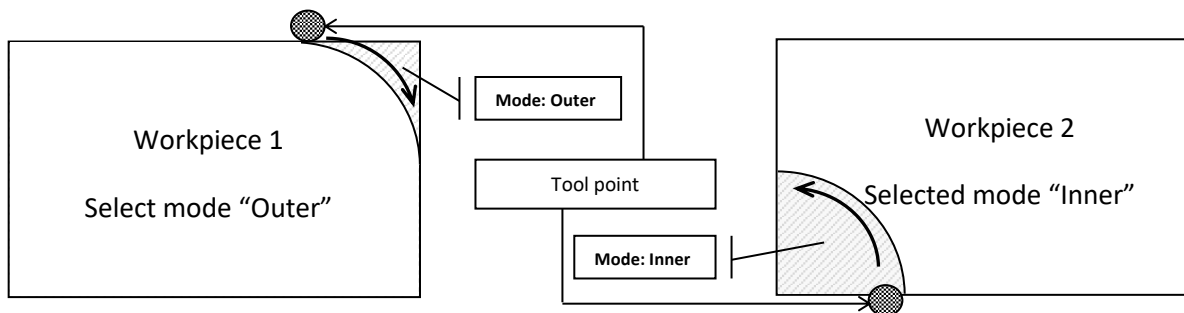

Enter radius of the circular area on the "Radius" line. Enter tool diameter of workpiece on the "Tool Dia" line. The angle of starting point process on "Angle 1" line, the angle of end process on "Angle 1" line should be entered. The maximum value of between the two points to be drilled is entered on the "Max Cut" line.

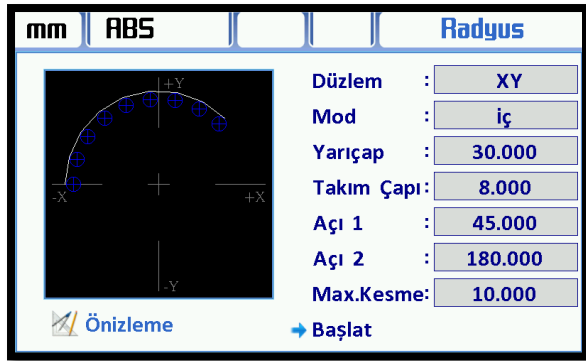

When all datums are entered, the preview image on the left side will be update according to these datums.

Click "Start" icon then press "ENT" button to starts.

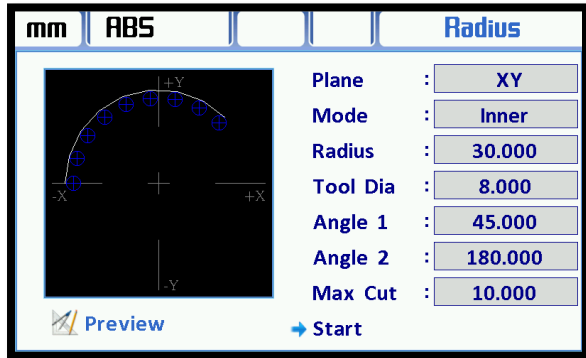

When the function startup the simulation screen will be open like a the side. The current position is shown with a yellow marker. The first point to be processed are indicated with white. The value which to be process axis is shown on left window. If these values are zero its mean is reached the first point. The first point is applied a process. The down arrow or "ENT" button is used to pass to the next point Count of point and the total number of points can be displayed on the left screen.

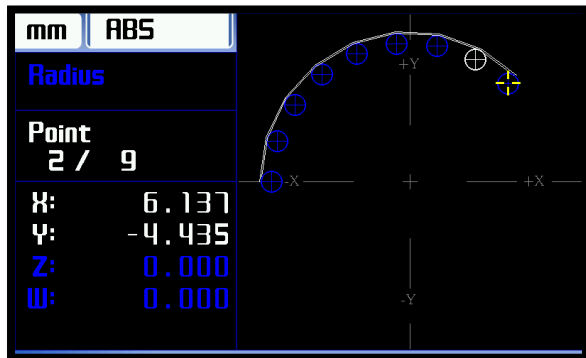

The first point can be processed and when press "ENT" or down arrow button the second point is displayed on the simulation screen as a white.

The new values are loaded to the axis. These axes are moved again until when the values reach to zero. When it is zero, reached the 2nd. Point. This point is processed too and to pass the 3rd point, press "ENT" or the down arrow button. All the points are processed in the same way and the function is exited with "Esc"

The "View" button can be used to pass the without simulation image. The operated axis values indicated with black, the none operated axis values indicated with blue on the screen.

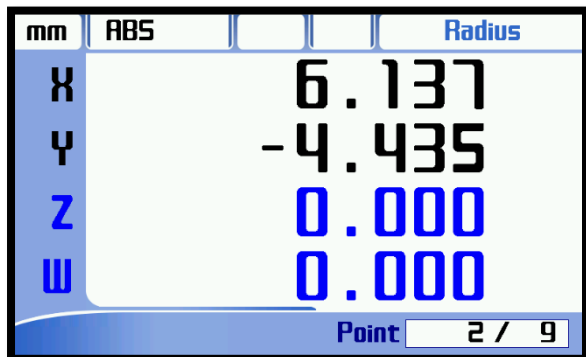

How many point and at the right bottom and the match point when courting are displayed at right bottom. These axes are moved again when the values reach to zero. And When it is zero the operation is done to pass the next point, press "ENT" or the down arrow button. the function is exited with "Esc" button.

5.4. Rectangular Pocket

This mode is intended to be used needs to be open a pool on the workpiece. the opening pool provides an opportunity to study for more smoothly and both the quality and faster with directing users. The starting point is the center of the pool will be opened.

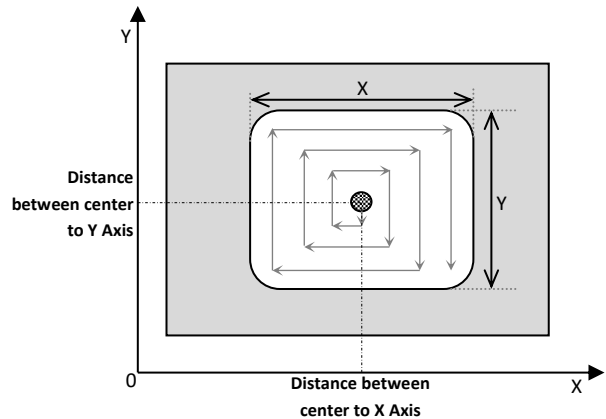
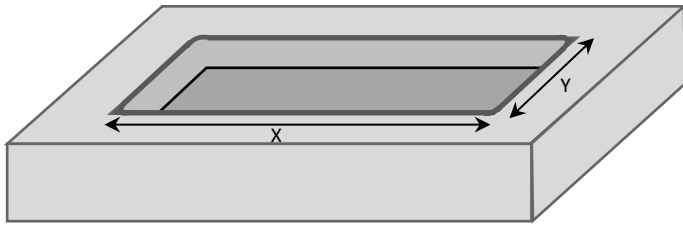

To enter the the Rectangular Pocket, press "3" button while on the function screen or to reach the "Rctnglr Pocket" with arrow keys then press "ENT" button.

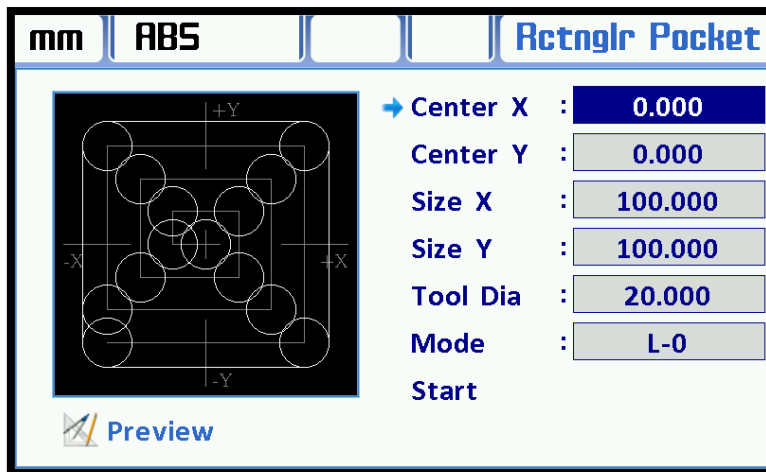

An screen is displayed 8 lines. The distance of starting point(center point) to X axis is entered on the "Center X" line. The distance of starting point(center point) to Y axis is entered on the "Center Y" line. The size of discharged pool on the X-axis length on the "Size X" line, The size of discharged pool on the Y-axis length on the "Size Y" line is entered. The diameter of the tool used to workpiece is entered on the "Tool Dia".

if the insert tipped tools is with radius the "L-1" on the "Mode" line can be choosen or it is radius, can be selected "L-0".

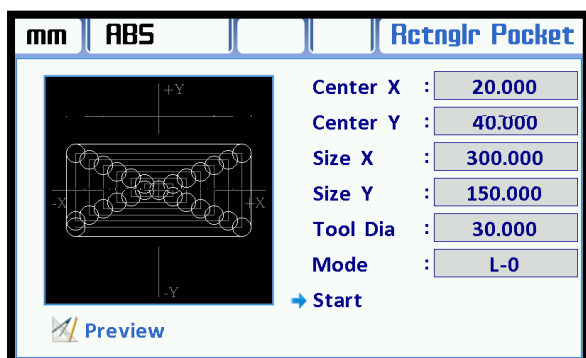

When all datums are entered, the preview image on the left side will be update according to these datums.

Click "Start" icon then press "ENT" button to start.

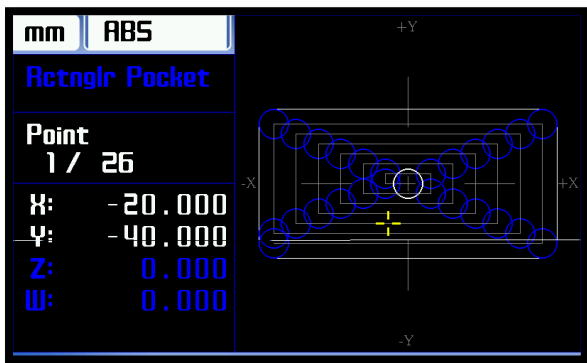

When the function startup the simulation screen will be open like a the side. The current position is shown with a yellow marker.

The first point to be processed are indicated with white. The value which to be When the function startup the simulation screen will be open like a the side. The current position is shown with a yellow marker. process axis is shown on left window. If these values are zero its mean is reached the first point. The first point is applied a process. The down arrow or "ENT" button is used to pass to the next point Count of point and the total number of points can be displayed on the left screen.

5.5. Taper Measure

Taper angle measuring body, the two points of an object by reference, tapered connecting apex angle of the workpiece is calculated.

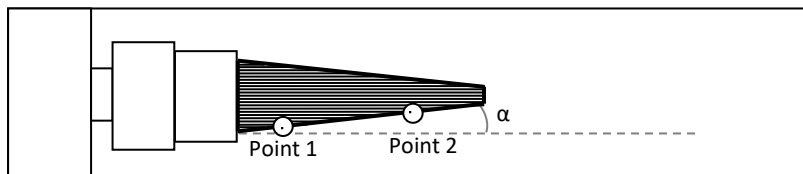

To enter the the Taper Measure, press "4" button while on the function screen or to reach the "Taper Measure" with arrow keys then press "ENT" button.

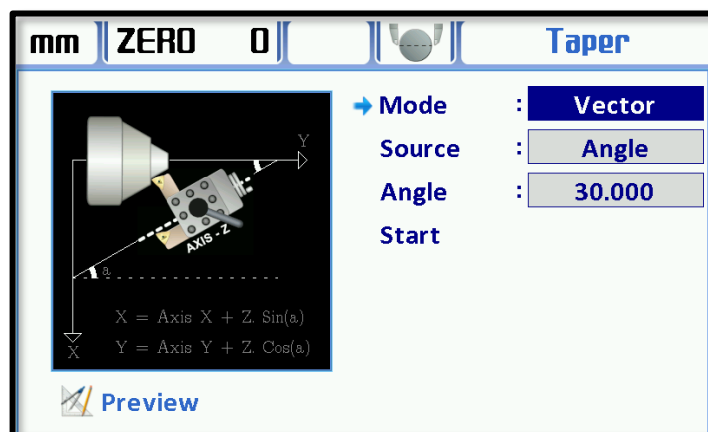

The image will display three lines.

The top row contains two different modes.

If **Tape Measurement** is selected from these modes:

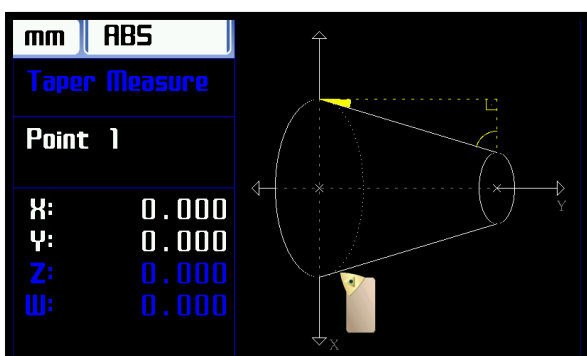

When the function startup the simulation screen will be open like a the side.

To measure taper angle measurement of the object it need to take two point reference measurement of edge bevel angle of the object.

When the function opens firstly the reference point which measurements must be taken is presented as representative.

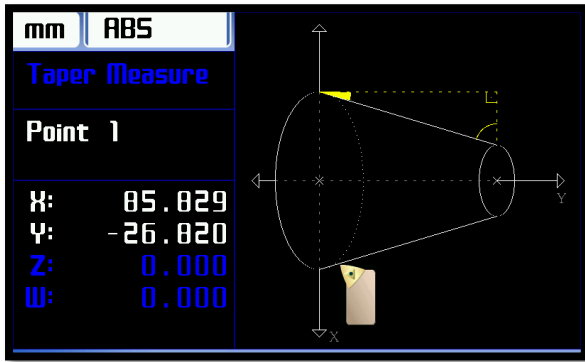

When insert the end of the reference point to one the “ENT” button is pressed.

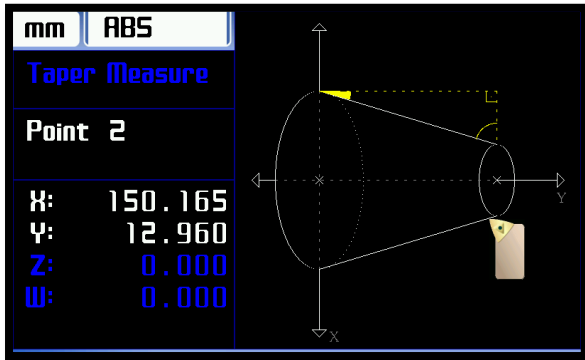

Simulation screen is updated for the reference point 2. Insert the end of the reference point is brought 2 and in order to show of angle the press "ENT" button.

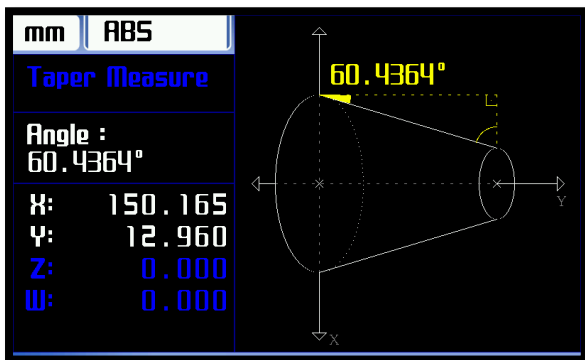

Insert the end of the 2nd reference point after the “ENT” button is pressed, the taper angle of the object will be shown on the screen.

If **Vector** is selected from these modes;

The source is selected as **Angle** or **W Axis** with direction arrows.



If source is selected as **Angle**;

Enter the desired angle value using the numeric buttons.

In this case, the diameter and height information of the cone is obtained dynamically with using the entered angle value and the information taken from Z axis.



If axis is selected as **W**;

The diameter and height information of the cone is obtained dynamically with using the axis information taken from encoder which is connected with lathe sport.

5.6. Angle Measure

The angle of the workpiece can be measured with Angle Measurement function.

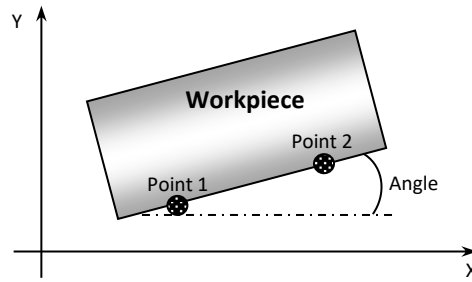

To enter the the Angle Measure Function, press "5" button while on the function screen or to reach the "Angle Measure" with arrow keys then press "ENT" button.

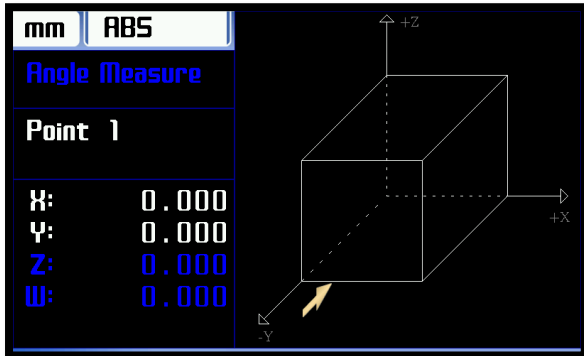

When the function startup the simulation screen will be open like a the side. The measuring axis should be chosen with up and down arrow buttons. The selected axis will be displayed as a white in the list on the left.

To angle measurement of workpiece, from the edge of the workpiece must be taken measurement of two reference points.

When the function opens firstly the reference point which measurements must be taken is presented as representative.

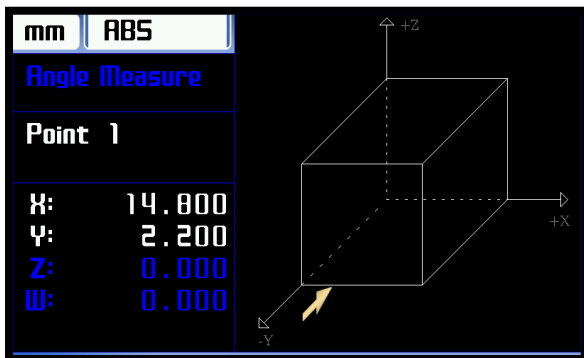

When insert the end of the reference point to one the "ENT" button is pressed.

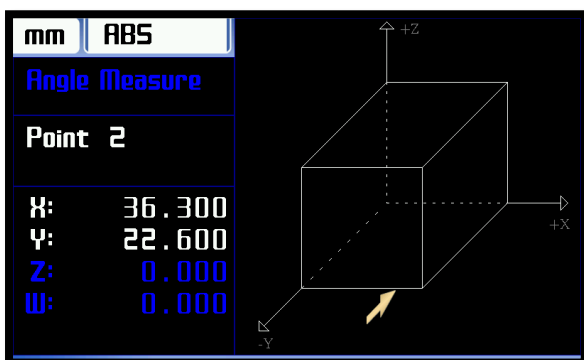

Simulation screen is updated for the reference point 2. Insert the end of the reference point is brought 2 and in order to show of angle the press "ENT" button.

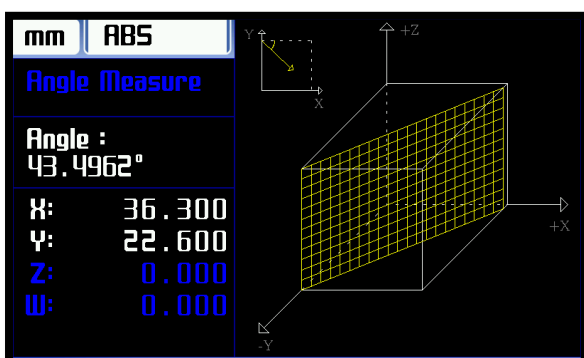

Insert the end of the 2nd reference point after the "ENT" button is pressed, the taper angle of the object will be shown on the screen.

5.7. EDM (Erosion Depth Control Function)

EDM is used to control the depth of the part to be processed. The offset value can be entered to compensate for errors arising from the electrode. It also applies to two different modes for relay position. Functions can be used in two different menus.

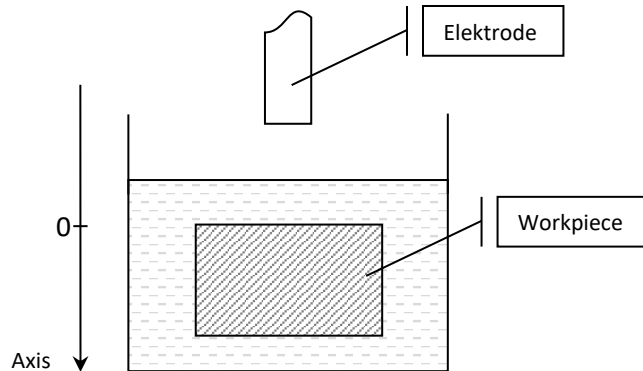

To enter the the EDM function, press "6" button while on the function screen or to reach the "EDM" with arrow keys then press "ENT" button

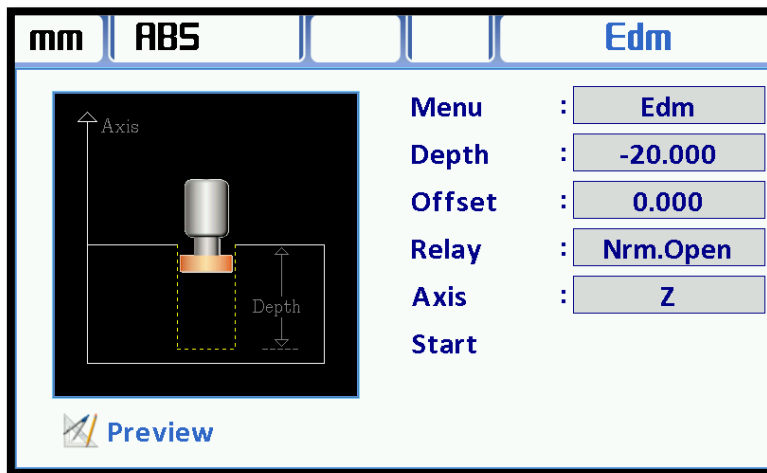

The image will display six lines.

There is two different mode option on the top of screen.

If the EDM is selected from these modes;

The depth value of electrode is entered on the "Depth" line. If the workpiece surface "0" is accepted, the depth value should be entered minus. The error which may arise from the electrode is entered on the "Offset" line. For example, due to the electrode wear caused in time, the depth difference is adjusted by giving a value on the "Offset" line. It is selected of relay contact position; normally open or normally close. The operation axis is selected on the "Axis" line.

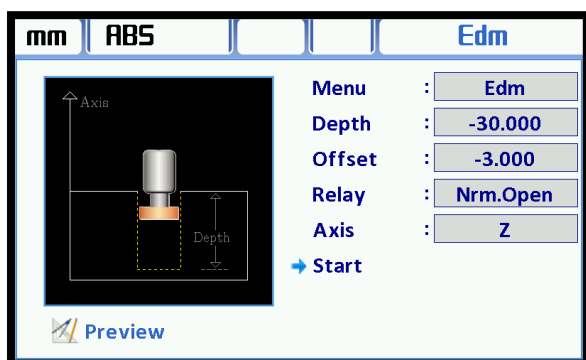

Click "Start" icon then press "ENT" button to start.

The relay remains towed until the axis value which to be process reach to value of "Offset + Depth".

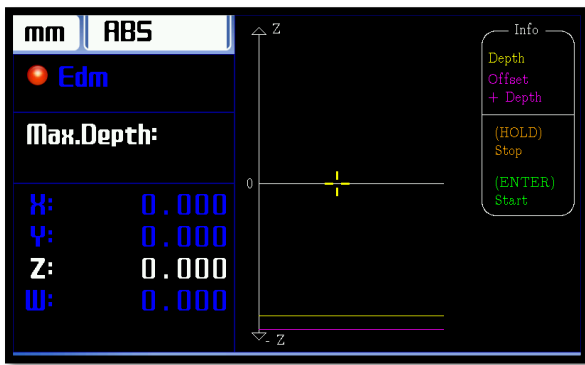

When the function startup the simulation screen will be open like a side. The current position is shown with a yellow marker.

The yellow line shows the value of depth, the pink line is depth + offset value. Operation is made according to value of pink. The axis values shows on the left side at the same time. The active axis white, others are blue. During the function active, the red led which next to image of EDM is blinking.

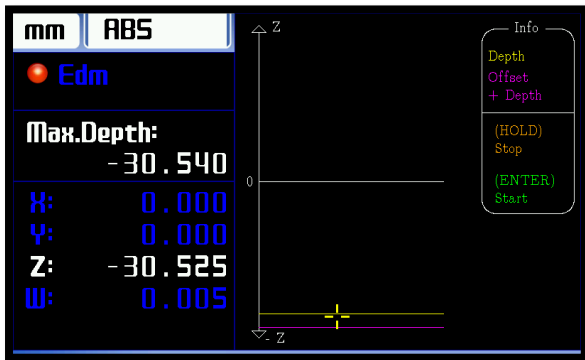

The action is displayed on the screen until Axis reaches the desired value.

The electrode moves in negative direction until yellow pointer reach to pink line and the relay is not changed on position.

The function can be paused with "Hold" button and continue with "ENT" button.

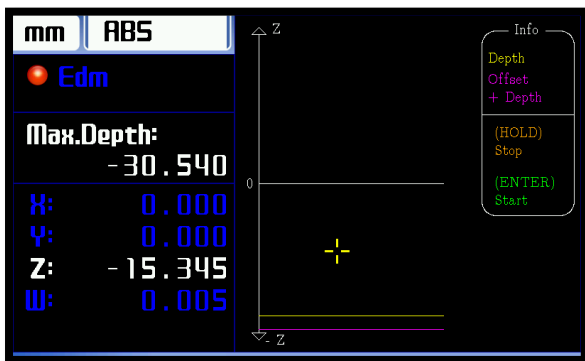

If Axis is moved in positive direction the "Max.Depth" value is displayed in white color on the left side.

The reminder about simulation is located in information box on the right side.

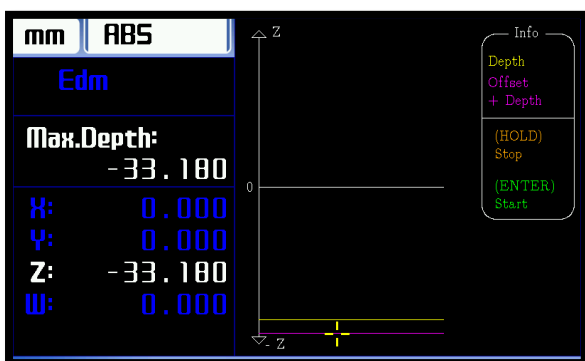

When the value reach the "Offset + Depth"(pink line) ADR gives beeps and the relay is change on position.

Press "ENT" button to start the process again

Axis values can be reset with "Reset" button while the simulation screen.

If the "Main Menu" is selected from these modes;

The depth value of electrode is entered on the "Depth" line. If the workpiece surface "0" is accepted, the depth value should be entered minus. The error which may arise from the electrode is entered on the "Offset" line. For example, due to the electrode wear caused in time, the depth difference is adjusted by giving a value on the "Offset" line. It is selected of relay contact position; normally open or normally close. The operation axis is selected on the "Axis" line.

When selected "Main Menu" if the desired value is over than the value of "Offset + Depth" the relay pulls, if under the relay leaves while working on main menu screen.

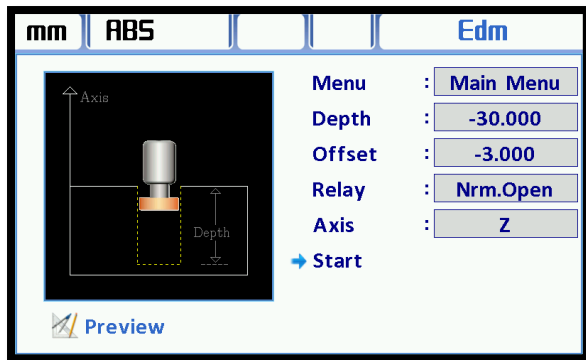

Click "Start" icon then press "ENT" button to start.

The relay remains towed until the axis value which to be process reach to value of "Offset + Depth".

فروشگاه کانون ابزار

تلفن : 021 66 39 39 00
 موبایل : 0912 147 3023
 www.ali5.ir

When the function is started, an icon will appear indicating that it was pulled on the right side of axis.

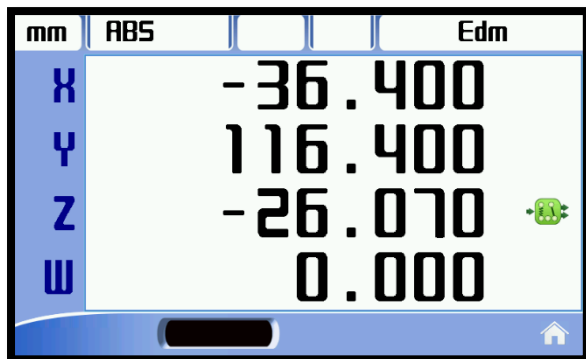
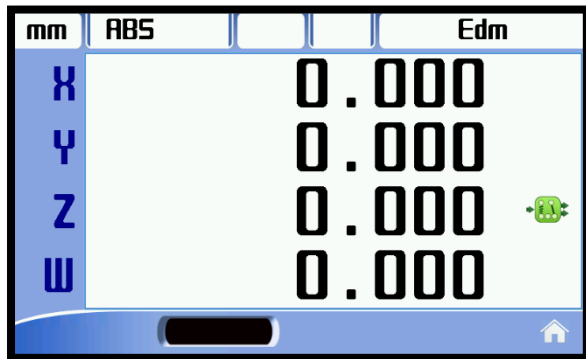

The relay remains in the same position until the axis value which to be process reach to value of "Offset + Depth".

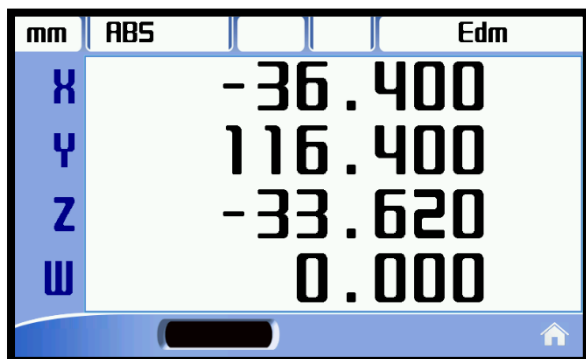

When the axis value is passed the value of the offset depth and the icon at right of the axis disappears.



Axis value falls below the value of the offset depth again the relay pulls again and the icon appears

If desired the function is closed, the function is enter again the selected "EDM" and save with "ENT" button. Function button with "Esc" to exit without starting.

5.8. Outputs

ADR 50 has 6 Open Collector outputs. These outputs can be associated with the desired axis.

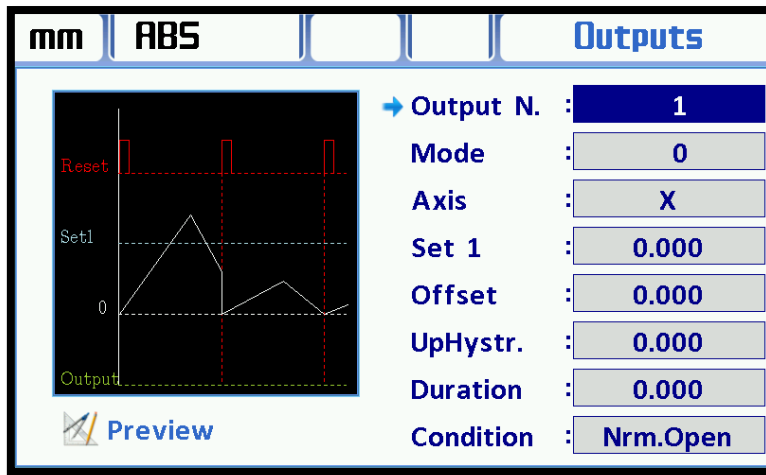

When the function is opened the eight line will be appear on the screen. But there is "Set2" line under the "Set 1" line and there is "UpHyst" line under the "DownHyst". A total of 10 lines of the variable is located.

The used output is selected on the "Output N." line.

The used mode is selected on the "Mode" line. There are 6 different modes. Each mode has a different scenario outputs. This output is also displayed in the preview screen on the left.

Belongs to the output axis is entered value of "Set 1" on the Axis line. The value of "Set 2" in the scenario is entered on the "Set 2".The value of "Set 2" is used only in "Mode 5".

The offset value is entered on the "Offset" line. this value is added to the Set value andthe scenario is applied according to this total value.

Top value of hysterical is entered on the "UpHyst" line. When Axis value increase the value entered here is added "Set+Offset" value.Lower value of hysterical is entered on the "DwnHyst" line. When Axis valuedecreased the value entered here is removed "Set+Offset value andthe scenario is applied accordingly.

The value is entered in seconds on the "Duration" line. This value determines how long the output will be given.If the value is not entered on this line the output varies according to scenario.

The normally open or normally closed output is selected on the "Condition" line.

Mode 0:

Even if other parameters selected outputs entered it does not function in any way.

The selected output disables in directly.

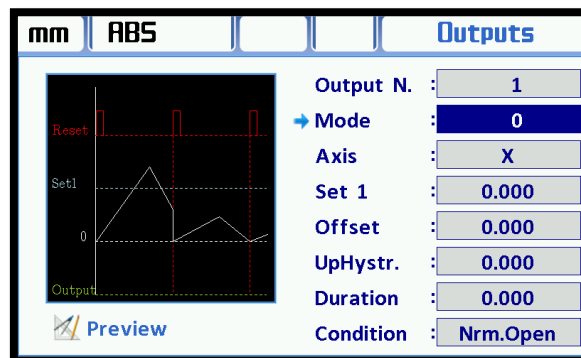

Mode 1:

When The value of Axis exceeds the value of set 1 the output is active. If the duration is not entered in, the output remains active, if the duration is entered, the output is remains active during the entered time and then switches to passive position.

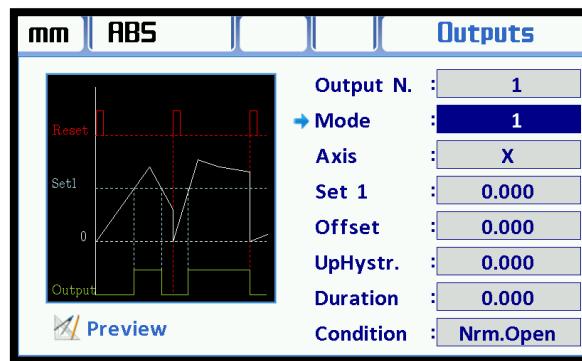

When the axis value falls below from set value the output is passive without depending on the duration value is entered. Optionally, hysteric and offset values can be entered.

Mode 2:

When the value of Axis exceeds the value of set 1 the output is active. The output remains active unless button (reset the axis) or reset the signal from the sensor.

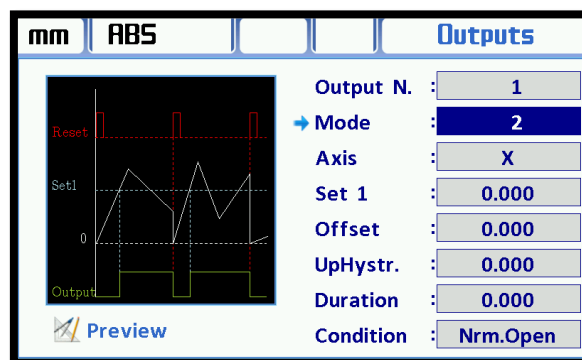

If the duration is not entered in, the output remains active, if the duration is entered, the output is remains active during the entered time and then switches to passive position. The output remains active unless it comes buton (reset the axis) or reset the signal. Optionally, hysteric and offset values can be entered.

Mode 3:

Axis value reaches Set 1 value axis value will be locked and the output is active. The output remains active unless it comes buton (reset the axis) or reset the signal and axis value remains in the locked position.

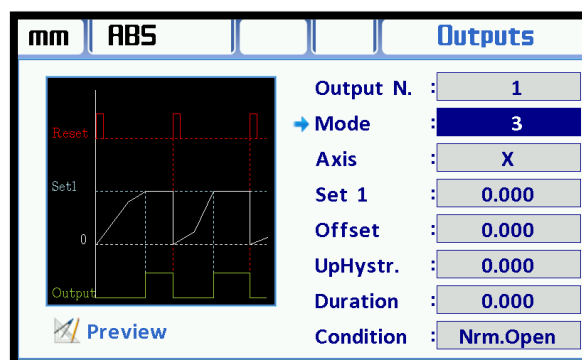

If the duration is entered, the output is remains active during the entered time and axis value remains in the locked position. End of the duration, the output becomes passive and Axis value is reset. Optionally, hysteric and offset values can be entered. Hysteresis lower rate is not used this mode.

Mode 4:

When Axis value reach each of the set value the output becomes active for the period specified. While Axis value is increased or decreased it is not important to reach Set 1 value. The output becomes active in both cases.

But When using this mode the duration must be entered.

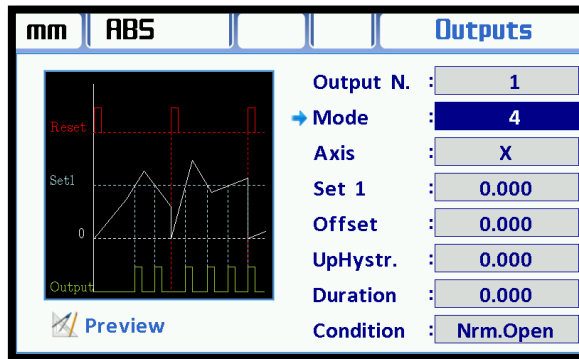

When the output is active it can be passive position again with button(reset axis) or reference sensor of sensor. Optionally, hysteric and offset values can be entered.

Mode 5:

When Axis value becomes between the values of Set 1 and Set 2 the output is active. Set 2 value is used only this mode.

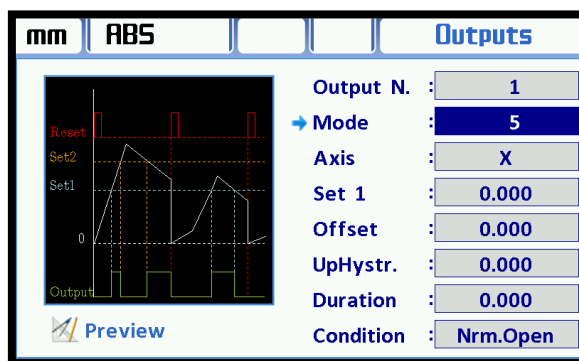

If the duration is entered, the output is remains active during the entered time and axis value remains in the locked position. End of the duration, the output becomes passive and Axis value is reset. Optionally, hysteric and offset values can be entered.

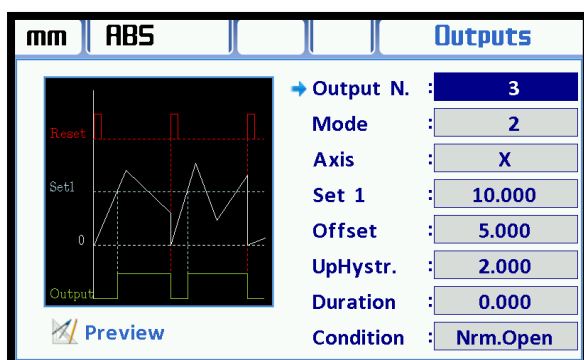

The parameters are set and it was recorded with "ENT" button in the example on the right side.

"Esc" button is used to pass the main screen.

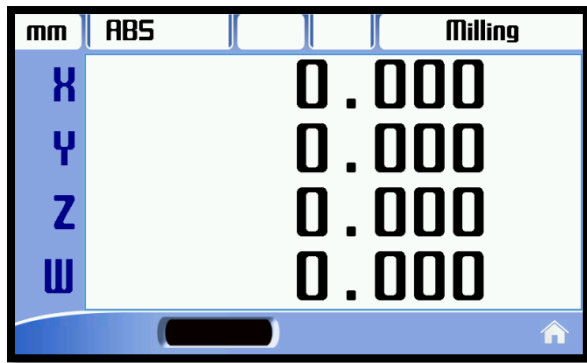

Main screen, Open Collector output status is indicated on the black display at bottom.

When the output is active it is indicated on this display.

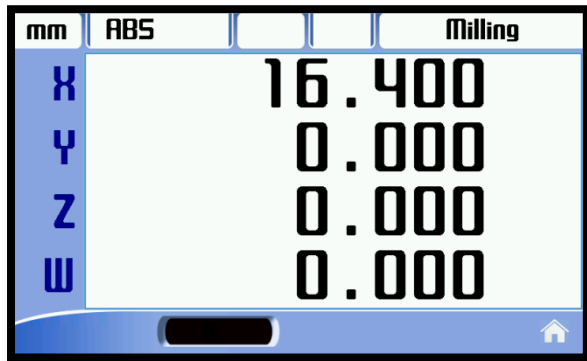

X axis can be selected and Set 1 value is given 10. But the output will not be active until the total value of X Axis is 17 in order to offset value is given 5 and upper rate of hysteresis is 2.



After X Axis value is passed 17 the 3 number of output will be active.

Output again in order to be passive, the reset signal must be sent to X Axis from sensor or Axis reset button.

5.9. User Program

User's drawing and measures is saved on the program table. Later, the work piece of technical picture can be processing with the help of origins in easily and error-free.

mm	ABS			Program
No	X	Y	Z	W
0	0.000	0.000	0.000	0.000
1	0.000	0.000	0.000	0.000
2	0.000	0.000	0.000	0.000
3	0.000	0.000	0.000	0.000
4	0.000	0.000	0.000	0.000
5	0.000	0.000	0.000	0.000
6	0.000	0.000	0.000	0.000
7	0.000	0.000	0.000	0.000
8	0.000	0.000	0.000	0.000
9	0.000	0.000	0.000	0.000
10	0.000	0.000	0.000	0.000
11	0.000	0.000	0.000	0.000
12	0.000	0.000	0.000	0.000
13	0.000	0.000	0.000	0.000
14	0.000	0.000	0.000	0.000

Line numbers represents the origin. There are 1000 lines. While processing it is recommended to work with "View" button and 2D image.

In order to reach the desired program line it can be easily to write "Orjin" then press "ENT" in easily.

mm	ZERO	0		Program
No	X	Y	Z	W
0	50.000	60.000	33.000	44.000
1	-50.000	60.000	44.000	55.000
2	70.000	20.000	55.000	66.000
3	-70.000	20.000	66.000	77.000
4	45.000	-30.000	77.000	88.000
5	-45.000	-30.000	88.000	99.000
6	20.000	-70.000	-33.000	-44.000
7	-20.000	-70.000	-44.000	-55.000
8	0.000	60.000	-55.000	-66.000
9	0.000	-110.000	-66.000	-77.000
10	-55.000	-66.000	-77.000	-88.000
11	-66.000	-77.000	-88.000	-99.000
12	0.000	0.000	0.000	0.000
13	0.000	0.000	0.000	0.000
14	0.000	0.000	0.000	0.000

After entering all program's values return to the main screen with "ESC" button.

mm	ZERO	0		Milling
X				-50.000
Y				-60.000
Z				-33.000
W				-44.000

The screen displays the values of orjin 0.

The user resets the values of an axis and processing the point by moving the tray.

The other orjin value is passed with down arrow buttons and the values is reseted by moving of the tray. At this point are processed.

The same process is repeated for all points.

mm	ABS			
User Program				
Page :	0			
Zero :	0			
X:	-50.000			
Y:	-60.000			
Z:	-33.000			
W:	-44.000			

2D simulation screen can be displayed by pressing "View" button. The processed point is marked with white. Axis value is also displayed in the lower left window. when these values are reseted the center point of processed would be reached.

To move to the next point is used down arrow button.

It can be reached to desired orjin with numeric buttons then "ENT" buttons.



ATEK ELEKTRONİK SENSÖR TEKNOLOJİLERİ SANAYİ VE TİCARET A.Ş.

📍 Gebze OSB, 800. Sokak, No:814 Gebze/KOCAELİ/TURKEY

☎ Tel: +90 262 673 76 00

☎ Fax : +90 262 673 76 08

🌐 Web: www.ateksensor.com

✉ E-Mail: info@ateksensor.com

فروشگاه کانون ابزار

تلفن : 021 66 39 39 00

موبایل : 0912 147 3023

www.ali5.ir